

Wires Data	
Type Motor	Squid Torque Motor
Power Wires (U,V,W)	Radox (**) mmq
Neutral Wire (K)	1mmq
Sensor Wires	AWG24
Length wires	1000 mm

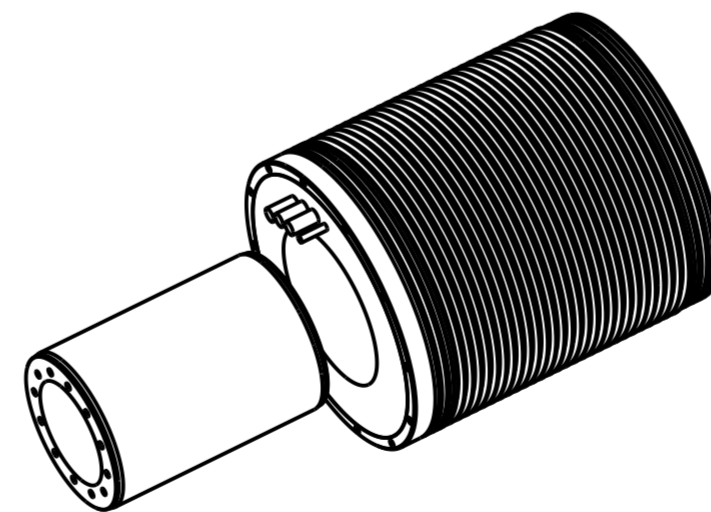

SCALE 1:5

NOTE: (*) These dimension can be increased for low polarity motors, and must be confirmed together with detailed datasheet definition.
 (**) Dimensions dependent on the motor winding configuration. General tolerance: geometrical tolerance (ISO 2768-2) class K linear tolerance (ISO 2768-2) class M.
 (***) Suggested position for hydraulic connectors.
 (****) To calculate the minimum number of screws, use follows formulas:
 X (N° Stator screw)= Stack lenght * 0.04
 Y (N° Rotor crews)= Stack lenght * 0.089
 Calculation for screws property class 8.8
 The number of screws can be reduced using higher property classes.

Type: Squid Torque Motor
 TK195-xxx-yyy

