

# TWX

Compact BLDC Integrated  
**Servo eMotor**  
CanOpen/EtherCAT FieldBus

**User Manual 2024**

Rev. 09/2024  
English



**1. General specifications, design, safety**

Safety notices.....5  
 Mechanical drawings.....6, 7  
 Environment, safety and EMC compatibility .....8  
 Specifications .....9, 10  
 Operational data .....11, 12  
 Brake data, conformities, nameplate.....13  
 Installation .....14  
 Leds behaviour .....15  
 Power stage supplier and electrical connections.....16  
 Connectors and pinout and connections.....17  
 Safe Torque Off (STO).....18  
 Safe Torque Off monitoring feedback (SIL3/PLe).....19

**2. CANopen protocol – DS301**

CANopen Protocol Parameters..... 20  
 Object Dictionary.....21  
 Data Type Encoding..... 22  
 LSS – DSP305 ..... 23  
 SDO..... 23  
 PDO..... 26  
 SYNC..... 27  
 EMCY Alarm list..... 28,29  
 NMT..... 29

**3. CANopen protocol – DS402**

Architecture of the drive ..... 31  
 Device Control..... 33  
 Profile Position Mode ..... 35  
 Profile Velocity Mode..... 36  
 Interpolated position Mode..... 37  
 Homing Mode..... 39  
 Rotary table mode ..... 41  
 Cyclic Synchronous Position Mode (CSP) .. 42  
 Cyclic Synchronous Velocity Mode (CSV)..... 42

**4. CockpitLT© set up and Commissioning**

Auxiliary digital input..... 43  
 Software overview.....44  
 Digital filters.....45  
 Special events and reactions.....45  
 Motor brake(optional) configuration and use.....45  
 Speed loop control .....46  
 Firmware upgrade ..... 47

**5. Object Dictionary Reference**

Communication objects..... 48  
 Profile specific objects..... 55  
 Manufacturer specific objects..... 62

**Beginner’s Tips**

Basic communication settings..... 72  
 Configuring an application..... 73  
 Running an application..... 75  
 Factor group setting ..... 76

A. Speed control loop schema.....78  
 B. Twx Motor default PDO parameters.....77  
 C. Twx Motor default control parameters.....81  
 D. Physical units vs. internal device units conversion.....81  
 E. Sorted index of the Object Dictionary .....81

### Devices references

This manual applies to Phase Motion Control BLDC e-motor TWX series with integrated servo

Model numbers: TWX 0503.A.40.4.XX TWX 0506.A.30.4.XX

### Documents References

CiA DS301 V4.02, CiA DSP305 V1.1, CiA DSP402 V4.1.0

IEC 61800-7-201 , IEC 82079-1:2019

EN ISO 20607 Safety of machinery – Instruction handbook – General drafting principles

Phase Motion Control CockpitLT Software User Manual

### Figures

Figure 1: Relation between basic objects in the Twx Motor.....	.....
Figure 2: State diagram of a device .....	.....
Figure 3: Device Control State Machine.....	.....
Figure 4: Single set point.....	.....
Figure 5: Change set immediately set point.....	.....
Figure 6: Interpolation with ip sync every 2 SYNC .....	.....
Figure 7: Interpolation start-up synchronization (ip sync every 3 SYNC) .....	.....
Figure 8: Homing method 19 and 20.....	.....
Figure 9: Homing method 21 and 22.....	.....
Figure 10: Homing method 26 and 30.....	.....
Figure 11: Control loop performance measurements.....	.....
Figure 12: Leds identification .....	.....
Figure 13: Structure of Device Type.....	.....
Figure 14: Structure of COB-ID Sync Message.....	.....
Figure 15: Structure of COB-ID Emergency Message .....	.....
Figure 16: Structure of Revision Number .....	.....
Figure 17: Structure of RPDO's COB-ID.....	.....
Figure 18: Structure of PDO Mapping Entry.....	.....
Figure 19: Structure of TPDO's COB-ID .....	.....
Figure 20: Structure of controlword.....	.....
Figure 21: Speed loop main schema.....	.....
Figure 22: Speed loop output schema .....	.....

### Tables

Table 1: Twx Motor CANopen features.....	.....
Table 2: Object dictionary layout.....	.....
Table 3: Baud rates.....	.....
Table 4: Abort codes.....	.....
Table 5: Error register reference .....	.....
Table 6: Twx Motor emergency codes reference.....	.....
Table 7: Trigger for state transition .....	.....
Table 8: NMT states and defined communication objects.....	.....
Table 9: Drive states .....	.....
Table 10: State transition .....	.....
Table 11: Commands in the controlword.....	.....
Table 12: Device Control related objects .....	.....
Table 13: Profile position commands .....	.....
Table 14: Profile position status .....	.....
Table 15: Profile Position Mode related objects.....	.....
Table 16: Profile velocity commands.....	.....
Table 17: Profile velocity status.....	.....
Table 18: Profile Velocity Mode related objects .....	.....
Table 19: Interpolated position commands.....	.....
Table 20: Interpolated position status .....	.....
Table 21: Interpolated Position Mode related objects .....	.....
Table 22: Homing commands .....	.....
Table 23: Homing status .....	.....
Table 24: Homing Mode related objects.....	.....
Table 25: Factor group related objects.....	.....
Table 26: Torque mode commands .....	.....
Table 27: Torque Mode related objects.....	.....
Table 28: Rotary table commands .....	.....
Table 29: Rotary table status .....	.....

Table 30: Rotary table related objects.....  
 Table 31: CockpitLT set-up and commissioning software overview.....  
 Table 32: Firmware upgrade.....  
 Table 33: Controlword operating mode specific bits.....  
 Table 34: Structure of the statusword .....  
 Table 35: Statusword operating mode specific bits.....  
 Table 36: Default control parameters.....

Online interactive version of this manual, reference documents and files, online support, are available at  
<https://www.phase.eu/integrated-servo-drive-twx/twx-manuals/>

## Introduction

Thank you for purchasing a **TWX Integrated Servo Motor** by Phase Motion Control.

### TWX Integrated Servo Motor Series

represents an high-quality eMotor with Integrated Servo Drive, that stands out for combining compactness, performance, safety and electromagnetic compatibility, in a **cubical frame**, **IOT** and **Industry 4.0** ready. Robust and fanless, TWX excels in reliability in harsh environments and demanding working conditions.

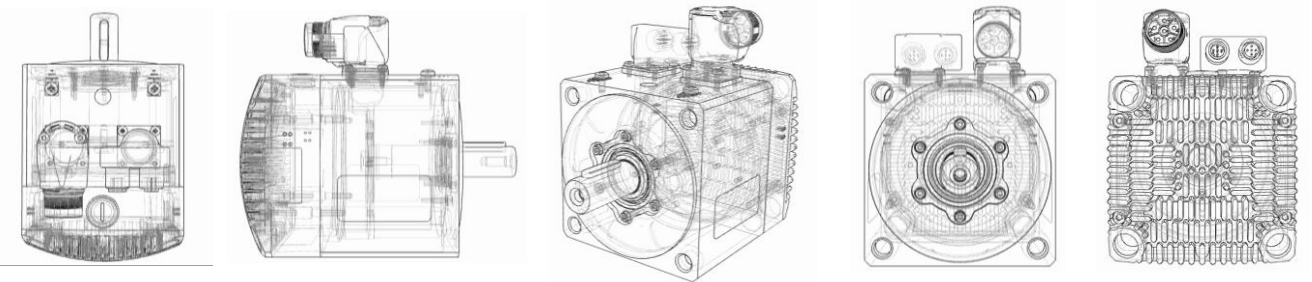

### TWX Integrated Servo Motor Series

fits **Robotics**, Multi-Axis CNC, Metrology, Textline, Testing, Medical, Additive Manufacturing, **IoT** Machinery Applications that requires high speed, torque and precision, flexibility, integration, plug&play capabilities, easy configuration and safer maintenance.

### TWX Integrated Servo Motor Series

integrates a brushless motor, a digital servo drive, a feedback position encoder or resolver, a static brake (optional), IN&OUT interfaces for Can or **EtherCAT** FieldBus communication, a power module and control logical section with **STO** safety function (optional), status Leds, easy PC commissioning and setup via **USB**.

### TWX Integrated Servo Motor Series

allows to design and build compact robots, arms and machines, with several eMotors connected in a single fieldbus line, minimizing noise, wiring and moving parts and maintenance.

DC-Bus architecture allows immediate **Energy Regeneration** from a motor to another in the same network.



This manual illustrates specifications and functions of the eMotor and Integrated Drive. Informations about safety, installation, wiring, configuration, and troubleshooting are provided as well.

## SAFETY FIRST! Warnings and Mandatory Notices



UP to 600 Volts in the described devices  
Section/disconnect all power source before installing, dis/connecting motor or any cables.



Magnetic fields is produced by motors and power devices – keep distances from people with any electronic medical devices (pacemakers implantable defibrillators or similar)



Pay special attention working near motors . Sudden and remote driven movements is always possible, especially with Canbus/EtherCAT active connections



Motors and connectors become hot when connected to the power (and remain hot even after power off). Don't touch any components: a burn injury may result



Pay special attention using metal made tools and screwdrivers near high voltage devices and cables



Risk of explosion and fire inside or near the motor and power unit. Establish a safe work area, and install devices away from combustible materials



Ground link needed – with adequate and wide contact surfaces



Specific HIGH voltage protecting gloves is necessary in mounting, connecting and working near Electric Motors, Power supplier and cables



ONLY Qualified and authorized from PMC personnel allowed to install and use the described devices

Informations in this manual are not intended to allow any unauthorized mechanical, electrical or software maintenance or repairs.



This manual must be read entirely before any physical or remote operation on servo motors, drives, power supply and any other electrical parts and cables.

Ensure that a copy of this manual is available to the machinery end user.

## Terms and abbreviations used

**PMC:** Phase Motion Control , **HV:** high voltage, **STO:** safe torque off function, **DC:** direct current, **AC:** alternate current , **PE** (protection earth connection), **eMotor:** electric motor, **PDO:** process data object, **SDO:** service data object, **OD:** object dictionary, **FW:** firmware, **CiA:** CAN in Automation, **TWX:** TWX Series Motor with Integrated Servo Drive, **Fieldbus:** communication network used for industry real-time distributed control and serial communication, **CAN:** Controller Area Network standard serial bus, **CanOpen:** Can based serial communication protocol, **EtherCAT:** Ethernet Control Automation Technology, **IoT:** Internet of Things

## Mechanical Drawings (No Brake versions)

### Model 3 Nm - TWX 0503.A.40.4

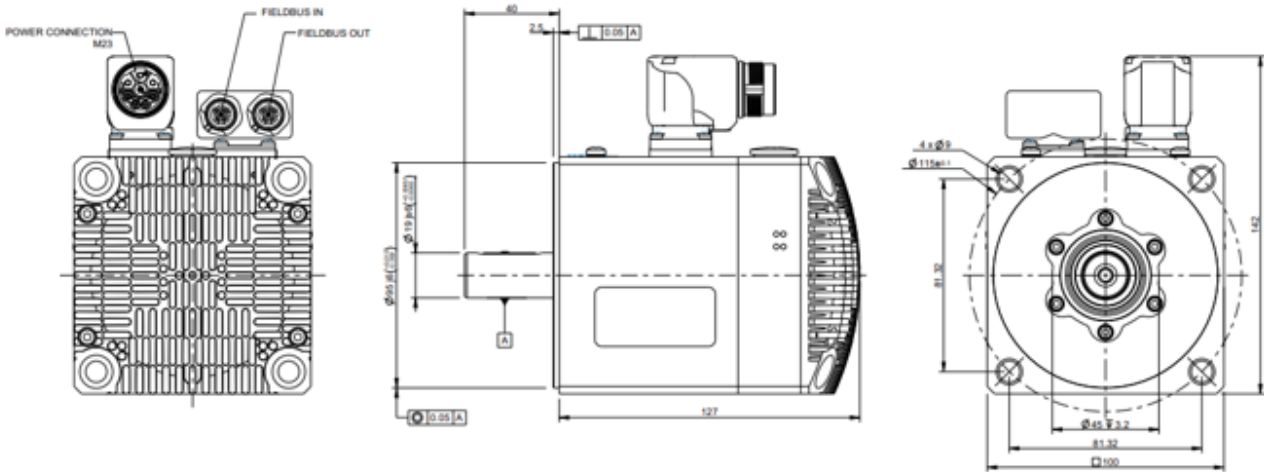

### Model 6 Nm - TWX 0506.A.30.4

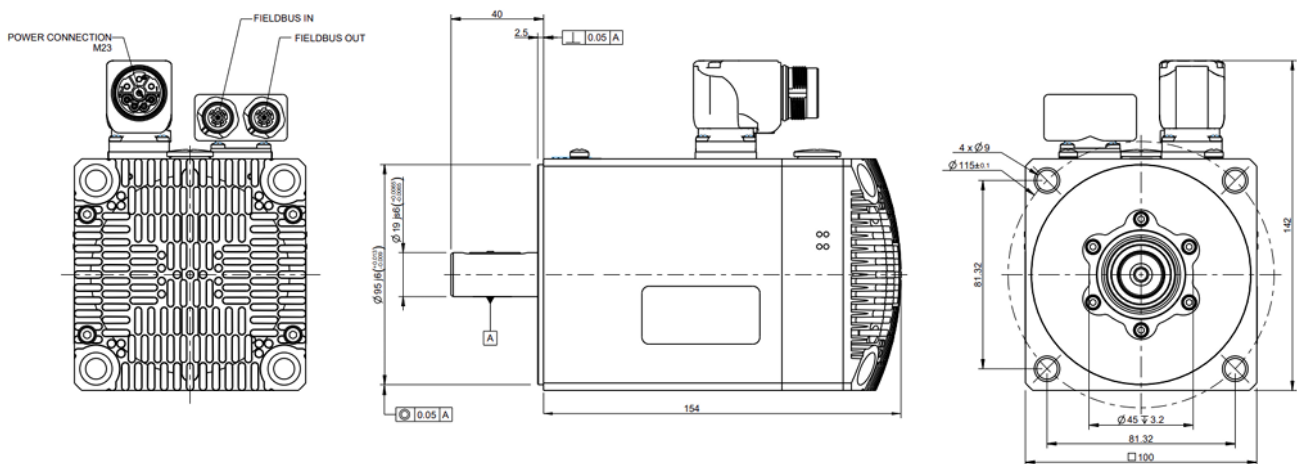

Mechanical Drawings (Integrated Brake versions)

Model 3 Nm w/ Integrated Brake - TWX 0503.A.40.4xxxBxxxxx

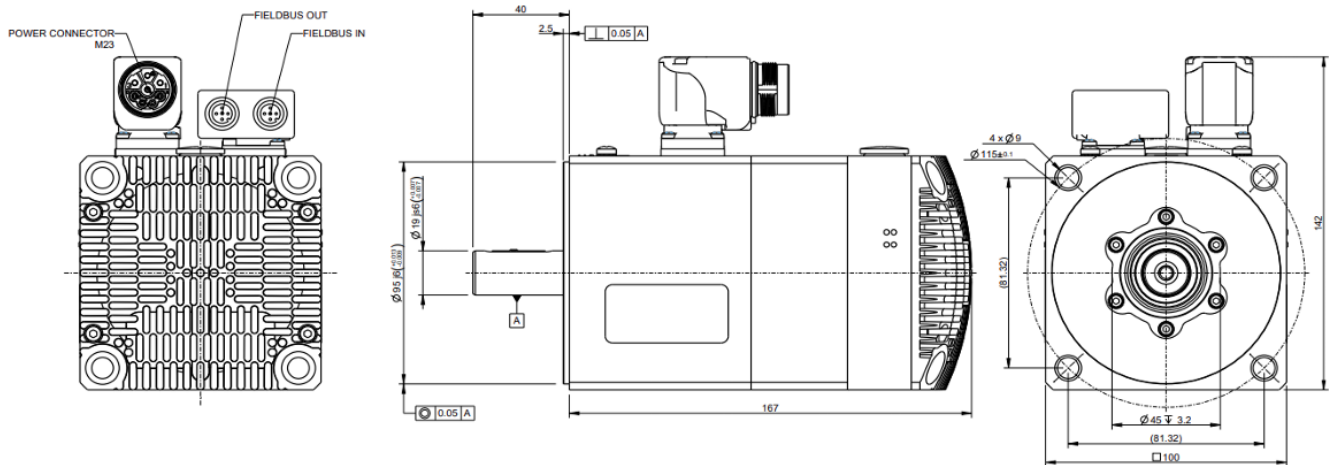

Model 6 Nm w/ Integrated Brake - TWX0506.A.30.4xxxBxxxxx

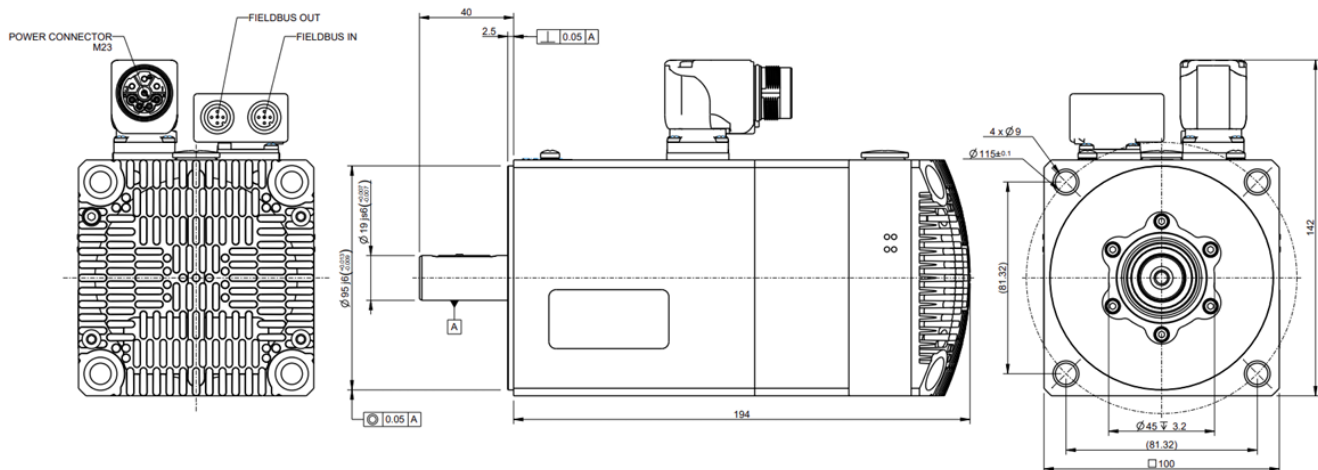

## Environment Conditions

Working/storage ambient temperature	-10°C e 65°C
Ambient humidity	95% max (no condensation)
Protection class	IP65 (connected connectors)

## Electromagnetic & Safety compatibility

This product accords to: EN 61800-5-1 (Safety) EN 61800-3 (EMC) e EN 61326-3-1 (EMC & Safety)

## Functional Safety Data for STO safety function

STO version without diagnostic		
Parameter	Value	Measuring Unit
Type (according to IEC/EN 61800-5-2)	A	--
Architecture (according to IEC/EN 61800-5-2)	1002	--
SFF (according to IEC/EN 61800-5-2)	<60	%
$\beta$ , $\beta_D$ (according to IEC/EN 61800-5-2)	2	%
PFH	5,17E-10	1/h
SIL (according to IEC/EN 61800-5-2)	2	--

STO version with diagnostic		
Parameter	Value	Measuring Unit
Type (according to IEC/EN 61800-5-2)	A	--
Category (according to EN ISO 13849-1/2)	3	--
Architecture (according to IEC/EN 61800-5-2)	1002	--
MTTF <sub>D</sub> (of each channel) (according to EN ISO 13849-1/2)	>100	Years
DC <sub>avg</sub> (according to EN ISO 13849-1/2)	>90	%
SFF (according to IEC/EN 61800-5-2)	>90	%
CCF (according to EN ISO 13849-1/2)	70	--
$\beta$ , $\beta_D$ (according to IEC/EN 61800-5-2)	2	%
PFH	5,17E-12	1/h
PL (according to EN ISO 13849-1/2)	e	--
SIL (according to IEC/EN 61800-5-2)	3	--

## Factory Set-Up and Commissioning

TWX motor drives are delivered to customers with the last standard firmware version, configured with default CanOpen, electrical, and motion control parameters table and PDO configuration.

Default CanOpen Parameters	Node number	1
	Baud rate	125 kbps



Before using a TWX e-motor or connecting it to a canbus network, users has to make sure that all parameters has the values requested by the specific usage and machinery in witch the motor is integrated. Don't touch or work near motor after Power On without appropriate safety measures.



Check or modify parameters using PMC *CockpitLt* software, and store them into the drive memory using the storing function (power off or reset does not keep modified values without storing)



After connecting the motor shaft to a load, the electrical and mechanical behaviour of motor will be different due to inertia load, and can lead to dangerous or unexpected movements. Conduct bench tests of the actual working conditions and load in a safe environment, before assembling and using the motor in machinery.



## Specifications

### Model 3NM - TWX 0503.A.40.4

Speed Data	Symbol	Value	Units
Nominal Speed (@ 540 V <sub>DC</sub> )	wn	2800	rpm
Maximum Speed	wmax	4000	rpm
Maximum Structural Speed	wp	4500	rpm
<b>Torque Data</b>			
S1 Low Speed Torque (flanged)	T0	3.7	Nm
S1 Nominal Torque (flanged)	Tn	2.2	Nm
S6 Peak Torque 40% duty T1=10s	Tax	6	Nm
<b>Electrical Data</b>			
Power supply (DC Bus)	Un	540	V <sub>oo</sub>
Nominal Voltage	Vn	219	V <sub>DC</sub>
Low Speed Current	I0	3.06	Arms
Nominal Current	In	1.82	Arms
Peak Current	Ipk	4.8	Arms
Torque Constant	Kt	1.25	Nm/Arms
<b>Power Data</b>			
Nominal Shaft Power		645	W
<b>Physical Data</b>			
Rotor Inertia	J	0.27 10 <sup>-3</sup>	Kgm <sup>2</sup>
Total weight	Mass	3.8	Kg
Protection Class		IP65	
Insulation Class		H	
<b>Thermal Data</b>			
Thermal Time Constant	Ta	382	s
S1 Motor Loss Low Speed	LO	80	W
Motor Thermal Protection Threshold		130	°C
Drive Thermal Protection Threshold		150	°C

## Specifications

### Model 6NM - TWX 0506.A.30.4

Speed Data	Symbol	Value	Units
Nominal Speed (@ 540 V <sub>DC</sub> )	wn	2800	rpm
Maximum Speed	wmax	3500	rpm
Maximum Structural Speed	wp	4200	rpm
Torque Data			
S1 Low Speed Torque (flanged )	T0	6.4	Nm
S1 Nominal Torque (flanged )	Tn	3.9	Nm
S6 Peak Torque 40%duty T1 =10s	Tax	10	Nm
Electrical Data			
Power supply (DC Bus )	Un	540	V <sub>DC</sub>
Nominal Voltage	Vn	299	Vrms
Low Speed Current	I0	3.89	Arms
Nominal Current	In	2.39	Arms
Peak Current	Ipk	6	Arms
Torque Constant	Kt	1.73	Nm/Arms
Power Data			
Nominal Shaft Power		1142	W
Physical Data			
Rotor Inertia	J	0.5110: <sup>3</sup>	Kgm <sup>2</sup>
Total weight	Mass	4.9	Kg
Protection Class		IP65	
Insulation Class		H	
Thermal Data			
Thermal Time Constant	Ta	453	s
S1 Motor Loss Low Speed	L0	110	W
Motor Thermal Protection Threshold		130	°C
Drive Thermal Protection Threshold		150	°C

Operational data

Model 3NM - TWX 0503.A.40.4

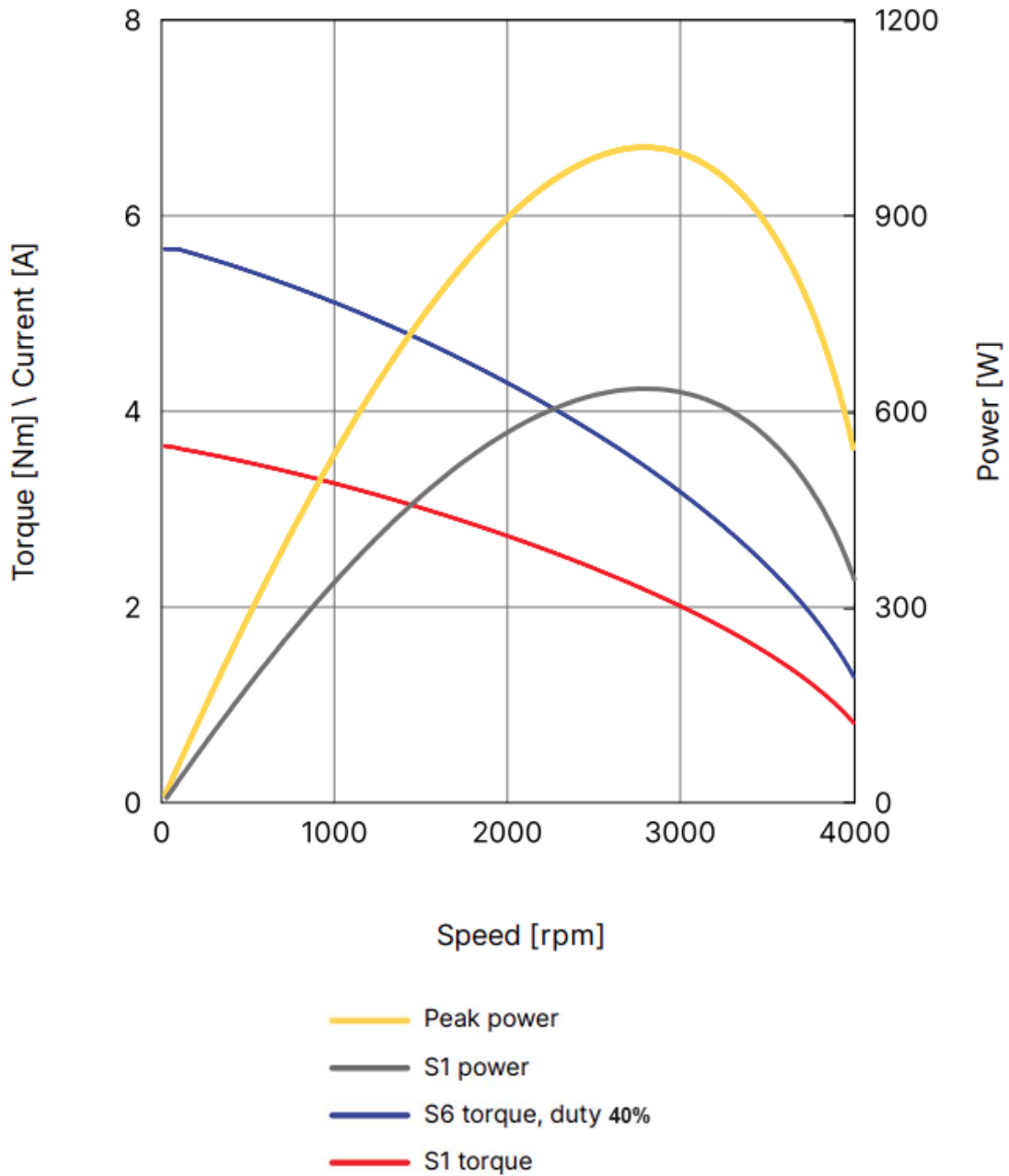

Operational data

Model 6NM - TWX 0506.A.30.4

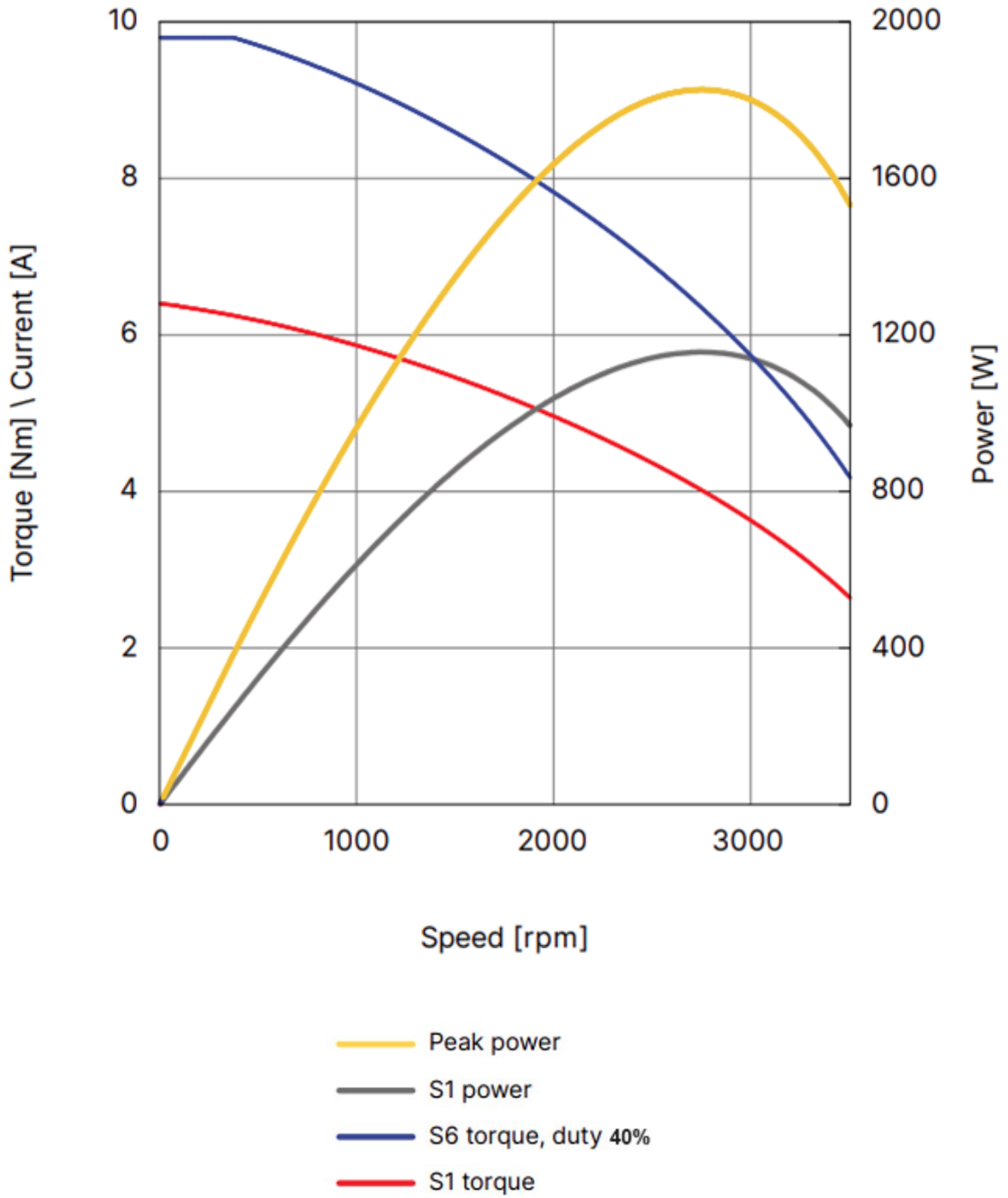

## Optional Brake data

	Symbol	Value	Units
Supply Voltage	$U_n$	24	$V_{DC}$
Power consumption	$P_{20}$	14	W
Stall Braking Torque (20°C)	$TB_k$	7.0	Nm
Rated Torque	$TB_{KN}$	3.8	Nm
Additional inertia	$JB_k$	$0.416 \cdot 10^{-4}$	$Kgm^2$
Weight	m	0.55	Kg

## Conformities

### Declaration of Conformity

For PMC components there are declarations of conformity available. These declarations confirm that the components are designed according to valid EC directives. If required, you can ask your sales representative for these declarations.

### Low-Voltage Directive

The PMC products of a drive system mentioned in this documentation comply with the requirements of the EC Directive

### EMC Directive

The PMC products of a drive system mentioned in this documentation comply with the requirements of the EC Directive

### Installation and Safety Instructions

Please read before the initial startup.

## Nameplate and serial number

Before working with the TWX Servo Motor and the DC Power Supply Unit, ensure there are no visible damages. Verify that the models you have taken from the package are correct for your application, match your order, and that you can provide the prescribed voltage supply for the specific motor.

Verify that serial number on nameplate corresponds with labels on the package, and paper test report too.

<b>TWX0506A.30.4N10BP</b>	
Tn 3.9 Nm	W 300 rad/s
Tpk 10 Nm	Vin 540 Vdc
Pat. Nr. 000000000	
Caution No Shocks on Shaft	
PHASE logo	CE symbol

TWX metal nameplate format example

## Installation

- Transport, installation and use of the drives are reserved to qualified staff (IEC 60364).
- The opening of the drive's enclosure or motors protections, or a defective installation, can lead to personal or material damage.
- The technical data on the unit's nameplates must be observed.
- The units must be installed and cooled according to the regulations stated in the corresponding documentation.
- Ensure that no components are bent or insulation distances changed during transport. The electronic components and contacts must not be touched.
- When working on an energized controller the valid national requirements for the prevention of accidents must be observed.
- The electrical installation must comply with applicable regulations (cable cross sections, fuses, protective conductor connections).
- All control inputs and outputs of the drives are insulated with a "basic" insulation (functional). Another level of protection must be implemented for personal safety against electrical contact.
- When using current-operated protective devices, please note that the controller have internal DC rectification. A DC fault current is therefore possible. Some differential current protection systems are made inoperative by DC current leakage. Use only "universal" or pulse operated protection devices. The RFI filter which is built into the drives cause a certain amount of leakage current to flow in the ground wires. This current may cause tripping of too sensitive differential device and need to be taken into account while sizing differential devices.
- Irrespective of the CE mark on the motor, it is reminded that the compliance of the required limit values with the legal EMC regulations remain the responsibility of the manufacturer of the system or machine.
- The RFI filter needs a ground connection. The typical application is not operable without ground connection.
- For installations different from the typical application (e.g.: use of unscreened cables, use of multiple drives, etc.) the conformity to the CE-EMC directive requires a check of the machine or system regarding EMC limits.
- The user of the machine is responsible for the compliance with the EMC directive.
- Screen all power cables from filters to drive and from drive to motor with shield coverage greater than 85%.
- Signal cables must always be shielded as above.
- In order to reduce the interference caused by the motor cable and the induced noise in the encoder connection cable, such wiring must be shorter than 15 meters. This limitation is necessary also for the protection of the drive itself. For longer cables, use appropriate snubber inductors.
- The shields and grounds connections have to be made on the chassis of the motor, on the specific screws distinguished by .
- It is important that the power wires are inserted in wire ways different from the signal and supply one and that any cross between the power and signal cables is carried out at right angle.
- If sensitive instruments are used (for example analogue, non preamplified transducers, load cells, thermocouples etc.) keep a safe distance between the instrumentation ground and the power ground.
- All devices (drives, filters, motors) must be grounded on a single ground bar, with ground wires as straight and short as possible.

## Status Led Location and Behaviour

Twx Motor are equipped with two couples of leds (a couple on each side of the motor case), for real time status and fault check, and to easily identificate the actual drive connected to the Commissioning Software.

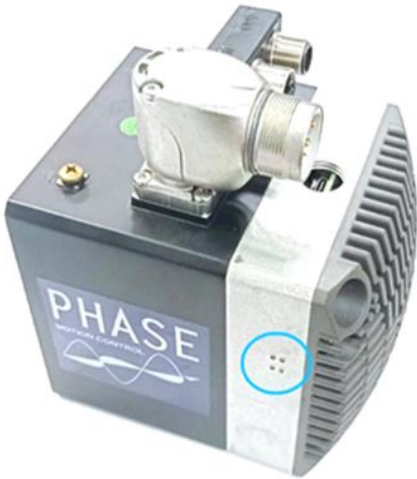

Figure 12: Leds position on motor case

IDLE			POWER FAIL		
Time [ms]	Green LED	Red LED	Time [ms]	Green LED	Red LED
0 to 500	ON		0 to 100		ON
500 to 1000			100 to 1000		

WARNING			FAULT		
Time [ms]	Green LED	Red LED	Time [ms]	Green LED	Red LED
0 to 100	ON	ON	0 to 50		ON
100 to 500	ON		50 to 100		
500 to 1000			100 to 150		ON
			150 to 200		ON
			200 to 250		ON
			250 to 650		ON
			650 to 700		ON
			700 to 750		ON
			750 to 800		ON
			800 to 850		ON
			850 to 900		ON

State POWER ENABLED			DRIVE IDENTIFICATION		
Time [ms]	Green LED	Red LED	Time [ms]	Green LED	Red LED
0 to 100	ON		0 to 50	ON	ON
100 to 200	OFF		50 to 100	OFF	OFF
200 to 300	ON				
300 to 800	OFF				

POWER ENABLED and WARNING			ALARM		
Time [ms]	Green LED	Red LED	Time [ms]	Green LED	Red LED
0 to 100	ON	ON	0 to 200		ON
100 to 200			200 to 400		
200 to 300	ON				
300 to 800					

Table 31: Leds behaviour in different motor states

**Yellow Led:** the drive is trasmitting data (only Ethercat version)

## Anomalies handling

Unexpected or repeated noise, heat, vibrations, visual inspection result, warning, fault, or suspicious behaviour from the TWX motor, the drive, the power source or the connections, has to be handled by users with attention.



DON'T connect, or use the motor or drive if you have any doubt or notice unexpected reaction, without contacting the official Phase Motion Control customer service.



If power fuses or disconnectors are activated, the user must immediately notify maintenance personnel and contact our technical support before restoring power to the drive



In case of anomalies, before any inspection or operations, disconnect the power source, activate the Safe Torque Off function, and ensure conditions to prevent electrical, thermal, or mechanical shocks or injuries

## AC-DC Power Unit with external braking resistor & Bluetooth

TWX series eMotors requires 300/600 VOLTS DC BUS and braking resistor management. It is recommended to use PMC *PX Series* DC Power Supply (DCbus 300V or 600V version)



- Input: Single phase 220Vac or Three phase 380Vac version
- Power on relay output (DCBus Ready and System ready signals)
- External DCBus capacitors charge capability
- Automatic DCBus capacitor discharge when system disable
- Dynamic braking (external resistor required)
- Desaturation protection of braking IGBT
- Over voltage, over current and over temperature protection
- Bluetooth Monitor
- Heat dissipation by a cooling fan
- Up to 3 TWX servo motors can be supplied in parallel



The DC Power Supply Unit must be installed inside an industrial electrical cabinet. Make sure that the specified temperature, humidity and vibration limits are not exceeded.



Before turn ON, ensure the external brake resistor is connected to prevent damages, fire, explosions and injuries. If the resistor is insufficient, or not present, overvoltages faults on the DC bus will happen. After overvoltage, check resistor before any other operations to prevent damages, fire, explosions and injuries.

## Electrical Specifications & Connections

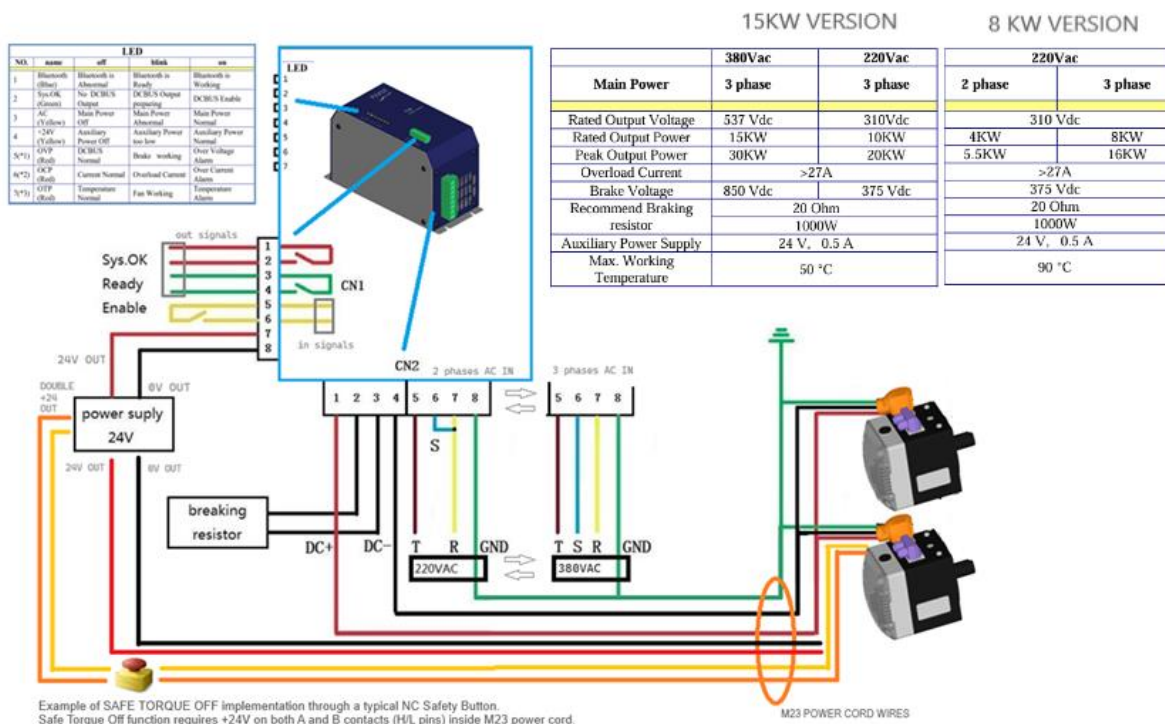

\*Complete 2 phases and 3 phases power units and datasheets available at [www.phase.eu](http://www.phase.eu)



UP to 600 Volts in the described devices – check all connections and polarities before Power On



Ground link needed – with adequate and wide contact surfaces



Specific HIGH voltage protecting gloves is necessary in mounting, connecting and working near Electric Motors, Power supplier and cables



## Connectors

PE screw terminals



DCbus (M23) In/Out Can/Ethercat (M12)



USB type C port



## Power and Fieldbus Connectors Pinout (\* for STO SIL3 version see next section)

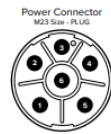
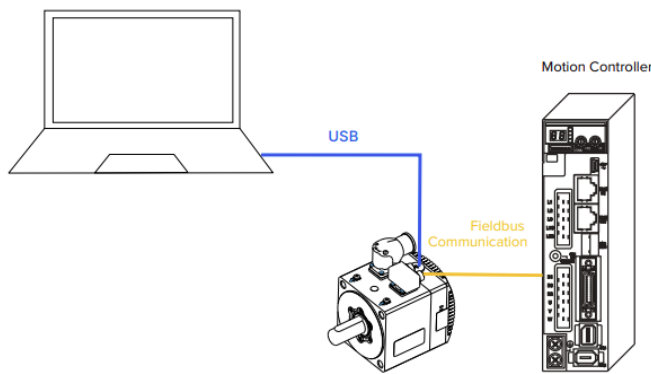

Power connector	
PHOENIX CONTACT 6pins SF-5EPINBAAD00	
Pin	Description
1	DC+
2	DC-
3	GND
4	Auxiliary input (+24V)
5	0V Supply
6	+24V Supply

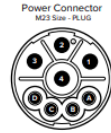

Power connector	
PHOENIX CONTACT 8pins SF-7EPINBAAD00	
Pin	Description
1	DC+
2	GND
3	DC-
4	0V Supply
A	+24V STO H Input
B	Auxiliary Input (+24V)
C	+24V Supply
D	+24V STO L Input

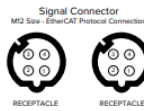

Signal connectors	
EtherCAT protocol (M12 Codification D)	
Pin	Description
1	Tx+
2	Rx+
3	Tx-
4	Rx-

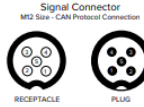

Signal connectors	
CANopen protocol (M12 Codification A)	
Pin	Description
1	Shield
2	+ 24 V Supply
3	CAN GND / 0V Supply
4	Can-H
5	Can-L

USB connections for commissioning + canopen / ethercat fieldbus

\*Complete 2 phases and 3 phases power units and datasheets available at [www.phase.eu](http://www.phase.eu)



UP to 600 Volts in the described devices



Use only the corresponding electrical connectors, checking good state and stability of connections



Specific HIGH voltage protecting gloves is necessary in mounting, connecting and working near Electric Motors, Power supplier and cables

## Safe Torque Off (STO) – Integrated Safety Function



**Safe Torque Off** is an important safety function integrated into TWX servo drive. It cuts off eMotor torque to prevent unexpected start up, such as during maintenance.

It is controlled by two dedicated M23 connector pins (A and B in pinout scheme). The drive enables torque only if a 24V voltage is supplied to both wires.

STO works at hardware level, independently from software and fieldbus

- Double independent channels lead to a safer system (single fault tolerance)
- Negative logic (protection activated in case of lost 24v signal)
- No need of main power disconnectors, relè, etc to achieve STO safety function

### Requirements

- Provide a DC +24V voltage signal to both STO pin of M23 power connector
- Install a NC switch or other NC device that cuts the connection when the switch is activated by operator, or the connection opens for other reasons (power failures, fires, damages, alarm from sensors, or any events that require to remove power to the motor for safety)

### Actions performed by STO when activated (one or both STO H/L pin lose the +24V signal)

- PWM power to motor is no more provided, even if the drive remains connected to power supply
- STO alarm status is saved into the internal drive variable (bit 3 of Statusword: 'fault')
- STO alarm packet is sent through the fieldBus to all other nodes
- STO alarm reset is requested: 1) restoring +24V signals to both STO H and L wires, typically unlocking the safety button, and 2) sending a reset controlword (0080h) via Fieldbus or USB Tool Cockpit LT reset command. Simply power off/restart the drive does not reset STO activation.

### Safety notice



STO is not an emergency brake: after power cutoff to motor, it could still rotate as a result of system inertia and can be dangerous in case of suspended loads.



STO doesn't actually shut down the source main power: if needed it has to be shutdown manually

### Extra safety function using Auxiliary 24V Input \*

As additional safety function, TWX motor allows to use the Auxiliary Input inside power cord (see pinout scheme) to perform by firmware a *quick stop* or a *power disable* action, choosing if action is performed on high or low Aux signal state. User must use the digital input section of CockpitLT to set the behaviour (as default No action will be performed on aux input).

sDriveProfile.sDigitalInputs...			{eDigInp_NoAction,eDigInp_NoAc...	Digital inputs option codes
diginp0	eDigInp_NoAction		eDigInp_NoAction	Digital input #0
diginp1	eDigInp_NoAction		✓ eDigInp_NoAction	Digital input #1
sSysClock			eDigInp_OnHighDisableVoltage	
			eDigInp_OnHighQuickStop	
			eDigInp_OnLowDisableVoltage	
			eDigInp_OnLowQuickStop	

\* Notice that such a function is managed via software and has not the same redundancy and safety measures of STO, so can not be considered a substitute of standard STO function

## STO Feedback Monitoring (SIL3/PLe version only)

With STO SIL3/PLe version, feedback terminals are provided for both STO H and STO L input signal to have a feedback from the drive regarding the actual STO H and L state respect to the levels sent by the user through dedicated pins of M23 Connector.

Output STO signals can be checked by the user reading voltage between HA-HB or LA-LB pins located in J16 connector, as shown below.

### STO In and Out levels and relative STO monitoring state

STO In	STO Out	STO Monitoring State
High	High	No internal faults
Low	Low	No internal faults
Low	High	faults on STO channels (unsafe)
High	Low	faults on STO channels (safe)

### STO Out terminals and wiring example

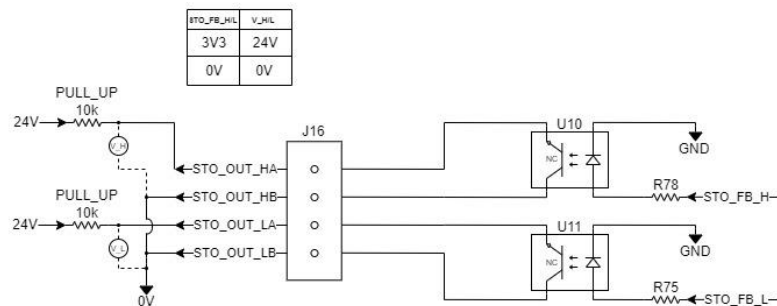

\* voltage reading from J16 connector is demanded to the user, for monitoring of correspondance between STO In and STO Out levels

### M23 Connector Pinout (STO SIL3/PLe version only)

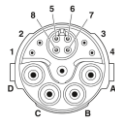

M23 Phoenix connector  
Mod. SH-8EPS48AAD00S

SH-8EPS48AAD00S	
Pin	Description
A	DC+
B	DC-
C	24V
D	0V
1	Not Used
2	24V_AUX
3	24V_STO_H
4	24V_STO_L
5	STO_OUT_HA
6	STO_OUT_HB
7	STO_OUT_LA
8	STO_OUT_LB
Central PIN	PE (Protection Earth)

## STO testing

STO function is tested in production phase, by the interruption of STO voltage signals, before and after the “burn in” test functional test in high level temperature condition.

## Introduction: master/slave FieldBus architecture

Twx drives use a subset of the standard CANopen protocol to provide read / write access to whole drive parameters (object directory) Several standard CANopen functions codes are supported as described in the CiA DS301.

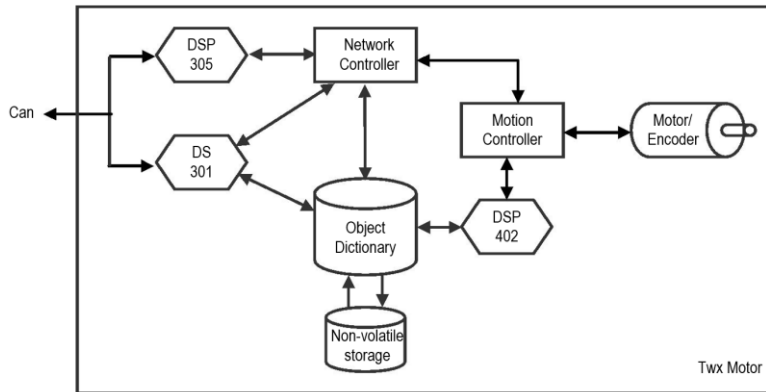

Figure 1: Relation between basic objects in the Twx Motor

The field bus that is used here is defined in ISO 11898 (Controller Area Network CAN for high-speed communication). The Layer-1/2 protocol (Physical Layer/Data Link Layer) that is implemented in all CAN modules provides, amongst other things, the requirements for data. Data transport or data request is made by means of a data telegram (Data Frame) with up to 8 bytes of user data, or by a data request telegram (Remote Frame or RTR). Communication Objects (COB) are labeled by an 11-bit Identifier (ID) that also determines the priority of Objects. A Layer-7 protocol (Application Layer) was developed, to decouple the application from the communication. The service elements that are provided by the Application Layer make it possible to implement an application that is spread across the network. These service elements are described in the CiA DS301.

The **Twx drives are slave systems** and then they need a master controller (hardware or software), that reads motor drive objects (variables) values and drive state, and sends commands using binary 'controlword', as well as synch packets to coordinate and give the movements timing (eg. CNC machine). The master use an internal or external clock to synch slave motors on same fieldbus.

The Twx series uses also a subset of the **CiA DSP402**, which standardizes the objects reference and relative motor behaviour for the digital servo drive motion control, in **CanOpen Fieldbus**.

TWX drives are also available with **EtherCAT Fieldbus** version, compliant with IEC standardization.

This flexibility and compatibility allow to easily integrate TWX eMotors in existing fieldbus network, and make them communicate con existing Master or existing code routines, even in case of future expansion with CiA or IEC compliant devices.

### Notation

In this manual all references from CiA (Can in Automation) standards are adapted to the specific Twx drives.

These does not includes features not implemented on the Twx drives.

All COBs are expressed in a structured table, including the COB-ID, where the length of the COB depends on how many bytes (Bx) are represented.

All objects are articulated is in the form **index.sub-index**, e.g. 1018h.2h means index 1018h sub-index 2h. If only **index** is specified then it means reference to the complete RECORD or ARRAY object, refer to §2.2.

All numerical data expressed inside a COB are always reordered starting from the least significant octet, refer to §2.3.

### CANopen protocol – DS301

The CANopen protocol is one of the most common CAN protocols. Since 1995 the CANopen specification is handed over to CAN in Automation (CiA) international users and manufacturers group. The European standardization authorities

have accepted the CANopen Device Specification version 4.01 as EN 50325-4. The main concept of CANopen is based on use of an **object dictionary** (basically device's variables, parameters, etc.). This dictionary gathers data related to the communication and the application. To access to these objects two methods are used: SDO & PDO.

**SDO** mean Service Data Object and is a confirmed way to exchange data of the object dictionary between master and slave. Usually a slave device is an SDO server, this mean that it could answer to a query originated by an SDO client, typically the master device of the network. Usually this protocol is **used to configure the internal parameters** of the device;The confirmed nature of this protocol generate a large amount of traffic on the CAN bus making it unsuitable for high-speed real-time communication.

**PDO** (Process Data Object) is an unconfirmed way and extremely configurable protocol to exchange high-speed real-time data, maximizing advantages of the CAN architecture. The transfer of PDOs is performed with no protocol overhead. The PDOs correspond to entries in the device Object Dictionary and provide the interface to the application objects. Data type and mapping of application objects into a PDO is determined by a corresponding PDO mapping structure within the Device Object Dictionary. Basically a PDO could be asynchronous (means that the transmission is triggered on a specific event or is remotely requested) or synchronous (means that the transmission is synchronized with the Synchronization Object).

**SYNC** producer, typically the **master**, broadcasts the Synchronization Object periodically. This SYNC provides the basic network clock. There can be a time jitter in transmission by the SYNC producer corresponding approximately to the latency due to some other COB being transmitted just before the SYNC. In order to guarantee timely access to the CAN bus the SYNC is given a very high priority identifier.

**Emergency objects** are triggered by the occurrence of a device internal error situation and are transmitted from an emergency producer (typically the slave) on the device. Emergency objects are suitable for interrupt type error alerts.

**The Network Management** (NMT) is node oriented and follows a master-slave structure. NMT objects are used for executing NMT services. Through NMT services, nodes are initialized, started, monitored, reset or stopped. All nodes are regarded as NMT slaves. An NMT Slave is uniquely identified in the network by its node-ID, a value in the range of [1..127]. NMT requires that one device in the network fulfils the function of the NMT Master.

**LSS** (Layer Setting Service) offers the possibility to inquire and change the settings of certain parameters of the local layers on a CANopen module with LSS Slave capabilities by a CANopen module with LSS Master capabilities via the CAN bus. The following parameters can be inquired and/or changed by the use of LSS:

- Node-ID of the CANopen Slave
- Bit timing parameters of the physical layer (baud rate)
- LSS address (Identity Object, 1018h)

By using LSS a LSS Slave can be configured for a CANopen network without using any devices like DIP-switches for setting the parameters. Then the configuration can be stored on a non-volatile memory.

## 2.1. CANopen Protocol Parameters

Standard features that are implemented in Twx Motor are:

<i>NMT:</i>	Slave only
<i>Baud rate / node-ID:</i>	1000 / 800 / 500 / 250 / 125 / 100 / 50 kbps; node 1 ÷ 127
<i>Server SDO:</i>	1
<i>Tx PDO:</i>	8
<i>Rx PDO:</i>	8
<i>PDO Mapping:</i>	User programmable (only in pre-operational state)
<i>PDO Modes:</i>	All types supported
<i>Emergency object:</i>	Yes
<i>Sync object:</i>	Yes
<i>Time object:</i>	No
<i>Error control protocols:</i>	Boot-up / Node Guarding / Heartbeat

Table 1: Twx Motor CANopen features

## 2.2. Object Dictionary

The most important part of a device profile is the Object Dictionary description. The Object Dictionary is essentially a grouping of objects accessible via the network in an ordered pre-defined fashion. The overall layout of the standard Object Dictionary is shown below. This layout closely conforms to other industrial serial bus system concepts:

<i>Index</i>	<i>Object</i>
0000h-0FFFh	data definition / reserved
1000h-1FFFh	communication profile area (DS301)
2000h-5FFFh	manufacturer specific area (Twx Motor specific)
6000h-9FFFh	standardized device profile area (DSP402)
A000h-FFFFh	other profiles / reserved

**Table 2: Object dictionary layout**

A 16-bit index is used to address all entries within the Object Dictionary. In case of a simple variable (**VAR**) the index directly references the value. In case of records (**RECORD**) and arrays (**ARRAY**) however, the index addresses the whole data structure. To allow individual elements of structures of data to be accessed via the network a sub-index is defined. For single Object Dictionary entries such as an UNSIGNED8, INTEGER32 etc. the value for the sub-index is always zero. For complex Object Dictionary entries such as arrays or records with multiple data fields the sub-index references fields within a data-structure pointed to by the main index. The fields accessed by the sub-index can be composed of different data types.

All objects accessible in the Twx Motor are described in §5.

### 2.3. Data Type Encoding

Basic data types used for accessing the object dictionary are:

- **INTEGER8** (8 bit signed integer)
- **INTEGER16** (16 bit signed integer)
- **INTEGER32** (32 bit signed integer)
- **UNSIGNED8** (8 bit unsigned integer)
- **UNSIGNED16** (16 bit unsigned integer)
- **UNSIGNED32** (32 bit unsigned integer)

For transmission across a CAN bus a bit sequence is reordered into a sequence of octets, starting from the least significant octet.

Examples:

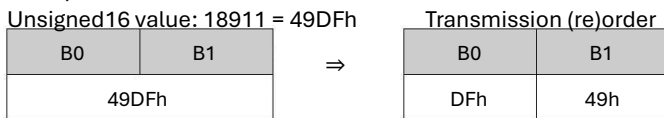

### 2.4. LSS – DSP305 (factory settings to communicate with TWX motor)

Since in the LSS Protocol all LSS Slaves use the same COB to send information to the LSS Master, there must be only one LSS Slave at a time that communicates with the LSS Master. For all protocols the LSS Master takes the initiative, a LSS Slave is only allowed to transmit within a confirmed service after it has been uniquely switched into configuration mode. Since there can be almost one confirmed LSS service outstanding at a time, the synchronization is established.

The factory default setting for the Twx Motor is node-ID equal to 1 and baud rate equal to 125kbps.

Master could switch the slave to configuration mode with the **switch mode global** command:

**Request (Master → Slave)**

COB-ID	B0	B1	B2	B3	B4	B5	B6	B7
7E5h	04h	01h	Reserved					

The Twx Motor support also the **switch mode selective** (see /2).

A non-standard command that find appliance only on Twx Motor is the **switch mode selective with serial number**. This command let a network with all powered-on and connected Twx Motor to switch to configuration mode one selected drive, providing only his serial number.

### Request (Master → Slave)

COB-ID	B0	B1	B2	B3	B4	B5	B6	B7
7E5h	80h	serial number				Reserved		

The response came only if desired slave exist and has switched to configuration mode.

### Response (Slave → Master)

COB-ID	B0	B1	B2	B3	B4	B5	B6	B7
7E4h	44h	reserved						

After a slave has switched to configuration mode the master could modify the node-ID with the following command:

### Request (Master → Slave)

COB-ID	B0	B1	B2	B3	B4	B5	B6	B7
7E5h	11h	node-ID	reserved					

node-ID: 01h to 7Fh

### Response (Slave → Master)

COB-ID	B0	B1	B2	B3	B4	B5	B6	B7
7E4h	11h	error code	spec. error	reserved				

error code: 0 means successful executing

This command alter all COB-ID that by default are in the form xxxh+node-ID (COB-ID of PDOs and of EMCY), but only if they have still the default value.

To configure the baud rate the following command is to be used:

### Request (Master → Slave)

COB-ID	B0	B1	B2	B3	B4	B5	B6	B7
7E5h	13h	00h	Speed idx	reserved				

speed idx: see [Table 3](#)

### Response (Slave → Master)

COB-ID	B0	B1	B2	B3	B4	B5	B6	B7
7E4h	13h	error code	spec. error	reserved				

error code: 0 means successful executing

Baud Rate	Speed idx
1000 kbps	0
800 kbps	1
500 kbps	2
250 kbps	3
125 kbps	4
100 kbps	5
50 kbps	6

**Table 3: Baud rates**

Then master can activate the new speed immediately with the following optional command:

**Request (Master → Slave)**

COB-ID	B0	B1	B2	B3	B4	B5	B6	B7
7E5h	15h	switch delay		reserved				

*switch delay:* the duration of the two periods of time to wait until the bit timing parameters switch is done (first period) and before transmitting any COB with the new bit timing parameters after performing the switch (second period). The time unit of switch delay is 1 ms.

Master now should store the new configuration in the internal non-volatile storage:

**Request (Master → Slave)**

COB-ID	B0	B1	B2	B3	B4	B5	B6	B7
7E5h	17h	reserved						

**Response (Slave → Master)**

COB-ID	B0	B1	B2	B3	B4	B5	B6	B7
7E4h	17h	error code	spec. error	reserved				

*error code:* 0 means successful executing

Finally, master should switch back the slave to the normal operation mode:

**Request (Master → Slave)**

COB-ID	B0	B1	B2	B3	B4	B5	B6	B7
7E5h	04h	00h	reserved					

For further details and examples please refer to / 2 and §6.1.

## 2.5. SDO

With Service Data Objects (SDO) the access to entries of a device Object Dictionary is provided. As these entries may contain data of arbitrary size and data type, SDOs can be used to transfer multiple data sets (each containing an arbitrary large block of data) from a client to a server (**download** or write) and vice versa (**upload** or read). The client can control via a multiplexor (16 bit index and 8 bit sub-index of the Object Dictionary) which data set is to be transferred. The contents of the data set are defined within the Object Dictionary.

Basically a SDO is transferred as a **sequence of segments**. Prior to transferring the segments there is an initialization phase where client and server prepare themselves for transferring the segments.

This is the sequence of the object **download**:



### Initialization download request (Master → Slave)

COB-ID	B0	B1	B2	B3	B4	B5	B6	B7
600h+node-ID	21h	index		subidx	data size			

*data size: this is the overall size (in bytes) of the object to be downloaded*

If the transfer could be done the server acknowledge the initialization phase:

### Initialization download response (Slave → Master)

COB-ID	B0	B1	B2	B3	B4	B5	B6	B7
580h+node-ID	60h	index		subidx	reserved			

Then the object download begin with a series of a segments:

### Segment download request (Master → Slave)

COB-ID	B0	B1	B2	B3	B4	B5	B6	B7
600h+node-ID	client cmd	segment data						

*client cmd:*

- bit 7-5: segment download request, equal to 0*
- bit 4: toggle bit: this bit must alternate for each subsequent segment that is downloaded. The first segment will have the toggle bit set to 0. The toggle bit will be equal for the request and the response COB*
- bit 3-1: indicates the number of bytes in **segment data** that do not contain data. Bytes [8-n, 7] do not contain data*
- bit 0: indicates whether there are still more segments to be downloaded: 0 means more segment to be downloaded, 1 means no more segments (this is the last segment)*

### Segment download response (Slave → Master)

COB-ID	B0	B1	B2	B3	B4	B5	B6	B7
580h+node-ID	server cmd	reserved						

*server cmd:*

- bit 7-5: segment download response, equal to 1*
- bit 4: toggle bit: this bit must alternate for each subsequent segment that is downloaded. The first segment will have the toggle bit set to 0. The toggle bit will be equal for the request and the response COB*
- bit 3-0: reserved, always 0*

This is the sequence of the object **upload**:

### Initialization upload request (Master → Slave)

COB-ID	B0	B1	B2	B3	B4	B5	B6	B7
600h+node-ID	40h	index		subidx	reserved			

If the transfer could be done the server acknowledge the initialization phase:

### Initialization upload response (Slave → Master)

COB-ID	B0	B1	B2	B3	B4	B5	B6	B7
580h+node-ID	41h	index		subidx	data size			

*Data size: this is the overall size (in bytes) of the object to be uploaded*

Then the object upload begin with a series of a segments:

### Segment upload request (Master → Slave)

COB-ID	B0	B1	B2	B3	B4	B5	B6	B7
600h+node-ID	client cmd	reserved						

*client cmd:*  
*bit 7-5: segment upload request, equal to 3*  
*bit 4: toggle bit: this bit must alternate for each subsequent segment that is uploaded. The first segment will have the toggle bit set to 0. The toggle bit will be equal for the request and the response COB*  
*bit 3-0: reserved, always 0*

### Segment upload response (Slave → Master)

COB-ID	B0	B1	B2	B3	B4	B5	B6	B7
580h+node-ID	server cmd	segment data						

*server cmd:*  
*bit 7-5: segment upload response, equal to 0*  
*bit 4: toggle bit: this bit must alternate for each subsequent segment that is uploaded. The first segment will have the toggle bit set to 0. The toggle bit will be equal for the request and the response COB*  
*bit 3-1: indicates the number of bytes in **segment data** that do not contain data. Bytes [8-n, 7] do not contain data*  
*bit 0: indicates whether there are still more segments to be uploaded: 0 means more segment to be uploaded, 1 means no more segments (this is the last segment)*

It is also possible to transfer a data set of up to four bytes during the initialization phase. This mechanism is called an **expedited transfer**:

### Expedited request (Master → Slave)

COB-ID	B0	B1	B2	B3	B4	B5	B6	B7
600h+node-ID	client cmd	index		subidx	data (optional)			

*client cmd:*  
*2Fh: expedited download of 8 bit data*  
*2Bh: expedited download of 16 bit data*  
*23h: expedited download of 32 bit data*  
*40h: expedited upload*

### Expedited response (Slave → Master)

COB-ID	B0	B1	B2	B3	B4	B5	B6	B7
580h+node-ID	server cmd	index		subidx	data (optional)			

*server cmd:*  
*60h: expedited download successful*  
*4Fh: expedited upload of 8 bit data successful*  
*4Bh: expedited upload of 16 bit data successful*  
*43h: expedited upload of 32 bit data successful*

If transfer would fail for some reason, both master and slave could send the **abort transfer** COB (it could be sent in any download/upload segment):

### Abort transfer (Master → Slave or Slave → Master)

COB-ID	B0	B1	B2	B3	B4	B5	B6	B7
600h+node-ID or 580h+node-ID	80h	index		subidx	abort code			

The **abort code** could be one of the following:

Abort code	Description
0503 0000h	SDO toggle bit not alternated during segmented transfer.
0504 0000h	SDO protocol timed out.
0504 0001h	SDO client/server command specifier not valid or unknown.
0504 0005h	Out of dynamic allocated memory.
0601 0001h	Attempt to read a write only object.
0601 0002h	Attempt to write a read only object.

Abort code	Description
0602 0000h	Object does not exist in the object dictionary.
0604 0041h	Object cannot be mapped to the PDO.
0604 0042h	The number and length of the objects to be mapped would exceed PDO length.
0604 0047h	SDO wrong COB length
0606 0000h	Access failed due to an hardware error of the internal non-volatile storage
0607 0010h	Data type does not match, length of service parameter does not match
0607 0012h	Data type does not match, length of service parameter too high
0607 0013h	Data type does not match, length of service parameter too low
0609 0011h	Sub-index does not exist.
0609 0030h	Value range of parameter exceeded (only for write access).
0609 0031h	Value of parameter written too high.
0609 0032h	Value of parameter written too low.
0609 0036h	Maximum value is less than minimum value.
0800 0020h	Data cannot be saved or restored from the internal non-volatile storage, wrong signature.
0800 0021h	Data cannot be saved or restored from the internal non-volatile storage because the power output is enabled
0800 0022h	Data cannot be transferred or stored to the application because of the present device state, depending on the object accessed either NMT state is operational or power output enabled, see description of the <b>Write override</b> attribute in §5.

Table 4: Abort codes

Examples:

Master download (via expedited transfer) to a slave the 16 bit value 1AC7h to the object 6066h.0h:

#### Request (Master → Slave)

COB-ID	B0	B1	B2	B3	B4	B5	B6	B7
600h+node-ID	2Bh	6066h		00h	1AC7h		0	

#### Response (Slave → Master)

COB-ID	B0	B1	B2	B3	B4	B5	B6	B7
580h+node-ID	60h	6066h		00h	0			

Master upload (via expedited transfer) from a slave the object 1018h.4h (that is a 32 bit value equal to 0098 9CABh):

#### Request (Master → Slave)

COB-ID	B0	B1	B2	B3	B4	B5	B6	B7
600h+node-ID	40h	1018h		04h	0			

#### Response (Slave → Master)

COB-ID	B0	B1	B2	B3	B4	B5	B6	B7
580h+node-ID	43h	1018h		04h	0098 9CABh			

For further details please refer to / 1.

## 2.6. PDO

**Process Data Objects** are used to transmit any process data for the process control. The PDOs are transmitted in broadcast and without any confirmation back to the transmitting device. There are two kinds of use for PDOs. The first is data transmission and the second data reception. It is distinguished in Transmit-PDOs (**TPDOs**, from slave to master) and Receive-PDOs (**RPDOs**, from master to slave).

**Synchronous** PDOs are transmitted on SYNC event and could be cyclic (means that the transmission is every n SYNC, with n between 1 and 240), acyclic (means that the transmission is triggered on event and then synchronized with SYNC event) or RTR-Only (only for TPDOs, means that master request the transmission by sending an RTR COB with same

COB-ID of the specific TPDO). The received RPDOs data is internally processed on the SYNC event, not immediately after receiving RPDO itself. The transmitted TPDOs data is sampled on the SYNC event, not at the time of transmission. TPDOs are dispatched immediately after the SYNC event, while RPDOs normally are dispatched from the master after all TPDOs and just before next SYNC event.

**Asynchronous** TPDOs could be triggered on event (means on changing data) or RTR-Only (means that master request the transmission by sending an RTR COB with same COB-ID of the specific TPDO). It is not guaranteed that the time on which data change and the time the TPDO are transmitted are the same. The received data of the asynchronous RPDOs are internally dispatched as soon as possible.

TPDOs could also have enabled the RTR allowed attribute, this means that, disregarding the transmission type, the master has the possibility to force the transmission by RTR COB.

Examples:

**Predefined RPDO #3, with control word (16 bit) and target position (32 bit):**

COB-ID	B0	B1	B2	B3	B4	B5
400h+node-ID	6040h.0h		607Ah.0h			

**Predefined TPDO #2, with status word (16 bit) and mode of operation display (8 bit):**

COB-ID	B0	B1	B2
280h+node-ID	6041h.0h		6061h.0h

In the Twx Motor it is possible to change the COB-ID (independently from the node-ID), the data mapping (for all PDOs) and specify an **inhibit time** (valid only for asynchronous TPDOs), that defines the minimum time that has to elapse between two consecutive invocations of a transmission service for that TPDO. In addition the Twx Motor provide an aux input triggered TPDO, refer to §4.6.

For all PDOs configuration there are specific entries in the object dictionary: 1400h and 1600h for RPDOs, 1800h and 1A00h for TPDOs. Refer to §6.2 for examples on how to fully configure PDOs.

For further details please refer to / 1.

## 2.7. SYNC

The **Synchronization Object** does not carry any data and is unconfirmed service.

**Sync COB (broadcast)**

COB-ID
080h

This object trigger the internal parameters exchange to and from all synchronous PDO buffers.

Twx Motor also use the SYNC object to synchronize his internal machine cycle with that of the Synchronization Object producer, but only if the SYNC cycle time is multiple of 250µs; also the time tolerance should be below ±5µs; the maximum recommended cycle time is 25ms. In addition it is suggested that the master start generating the SYNC object at least 100ms before **Start** remote node command and/or before enabling output power, to let drive synchronization. This feature (enabled by default) could be disabled if the user experience troubles with tolerance greater than specified.

The Twx Motor also monitor continuously the time period of the SYNC object, giving the user the ability to have a feedback on the **quality of the SYNC** object; this is given in the form of three parameters, the minimum cycle time, the maximum cycle time and the average cycle time. Those parameters are updated every user-specified amount of time (default 2 seconds), giving back the cycle time quality of the past period and letting the user never miss any intermittently discontinuity of the SYNC (e.g. the missing transmission of SYNC objects). The statistics are not cumulative, at the end of every update time period the drive reset the internal counters. Please note that in the Twx Motor all the EMCY, NMT and SDO objects are not internally synchronized with the SYNC object, then they could be dispatched at any time.

The SYNC related objects are: 1005h.0h, 60C2h, 60C3h, 5110h.0h, 5111h.0h, 5112h.0h, 530Bh.0h .

For further details please refer to / 1.

## 2.8. EMCY (Alarms)

Twx Motor support the emergency object, both for hardware and software faults. An emergency object is transmitted only once per 'error event'.

### Emergency COB (broadcast)

COB-ID	B0	B1	B2	B3	B4	B5	B6	B7
080h+node-ID	error code		error register	Twx Motor error register				reserved

*error code:* standard CiA error code (object 603Fh.0h)

*error register:* standard CiA error register (object 1001h.0h)

*Twx Motor error reg.:* mapped in the manufacturer status register (object 1002h.0h)

Every bit in the **error register** refer to a category of faults, more than one bit at time could be set to 1, meaning that more than one fault is active. Bit 0 is set to 1 if one or more faults are active, is reset to 0 if all faults are cleared.

Every bit in the **Twx Motor error register** refer to a specific faults of the motion controller and the OS but the communication module; more than one bit at time could be set to 1, meaning that more than one fault is active.

Bit	Meaning
0	generic error
1	current
2	voltage
3	temperature
4	communication error (overrun, error state)
5	device profile specific
7	manufacturer specific

Table 5: Error register reference

After the fault is cleared the slave transmit and EMCY object with **error code** equal to 0h, meaning that one fault is cleared. The other fields report remaining active faults; if none, all fields will be 0h.

Except when specified, the behaviour of non-fatal faults are described in the Fault Reaction option code (object 605Eh.0h).

Severity	Description	Error register	Error code
Fatal	"Power IGBT desaturation"	0x02	0x2110
Fatal	"Power overcurrent"	0x02	0x2310
Fatal	"Power overvoltage"	0x04	0x3210
Fatal	"Invalid current offsets"	0x02	0x5210
Fatal	"Power IGBT overtemperature"	0x08	0x4310
Fatal	"Power IGBT low power supply"	0x20	0x5114
Fatal	"Power IGBT management system fail"	0x80	0x7401
Fatal	"STO inputs mismatch"	0x20	0x9002
Fatal	"Motor overtemperature"	0x08	0x4211
Fatal	"SinCos encoder low analog levels"	0x80	0x7391
Fatal	"Endat encoder fault"	0x80	0x7392

NonFatal	"CANOpen Error Control Protocol Timeout"	0x10	0x8130
NonFatal	"CAN RX Overrun"	0x10	0x8111
NonFatal	"CAN TX Overrun"	0x10	0x8112
NonFatal	"CANOpen RX PDO Length Error"	0x10	0x8220
NonFatal	"CANOpen RX PDO Timeout"	0x10	0x8250
NonFatal	"CANOpen RX PDO Overrun"	0x10	0x8113
NonFatal	"CANOpen TX PDO Overrun"	0x10	0x8114
NonFatal	"CANOpen PDO Creation Error"	0x20	0xff40
NonFatal	"CANOpen Sync Overrun"	0x10	0x8115
NonFatal	"CANOpen Sync Error"	0x10	0x8700
NonFatal	"CAN Module Passive Mode"	0x10	0x8120
Info	"CAN Module exit from BusOff"	0x10	0x8140
NonFatal	"CAN Module HW Overrun"	0x10	0x8110

Table 6: Twx Motor emergency codes reference

The error register is mapped to the object 1001h.0h and the Twx Motor error register is mapped to the object 1002h.0h, while the last error code is mapped in the object 603Fh.0h. For further information on faults behaviour refer to §3.2.

## 2.9. NMT

The Network Management (NMT) divides in two categories, as follow.

### 2.9.1. Module Control Services

Through Module Control Services, the NMT master controls the state of the NMT slaves. The state attribute is one of the values {STOPPED, PRE-OPERATIONAL, OPERATIONAL, INITIALISING}. The Module Control Services can be performed with a certain node or with all nodes simultaneously.

<sup>†</sup> This event trigger a special fault reaction: the three power output lines are shorted together, acting both as brake for the motor and as a brake resistor to reduce DC-link voltage

<sup>‡</sup> This emergency code trigger an Abort Connection event, which the behaviour is defined by the object 6007h.0h

**NMT COB**

COB-ID	B0	B1
000h	CS	node-ID

CS: 01h: **start** remote node  
 02h: **stop** remote node  
 80h: enter **pre-operational** remote node  
 81h: **reset** remote node  
 82h: **reset communication** of remote node

Node-ID: Node-ID of the remote node or 00h for broadcast to all nodes

Immediately after power-on the node enter in the PRE-OPERATIONAL state; then master could follow these steps to set-up the nodes before enabling them to the OPERATIONAL state:

- Configuration of all device parameters, including communication parameters (via Default SDO)
- start transmission of SYNC, wait for synchronization of all devices
- Start of Node Guarding

All of those operations are optional as Twx Motor support full parameters saving to internal non-volatile storage and the requirement of SYNC depend from the specific application.

The state transition (except the PRE-OPERATIONAL to OPERATIONAL transition) could trigger an Abort Connection event, which the behaviour is defined by the object 6007h.0h. State transitions are caused by reception of an NMT COB used for module control services or an hardware reset.

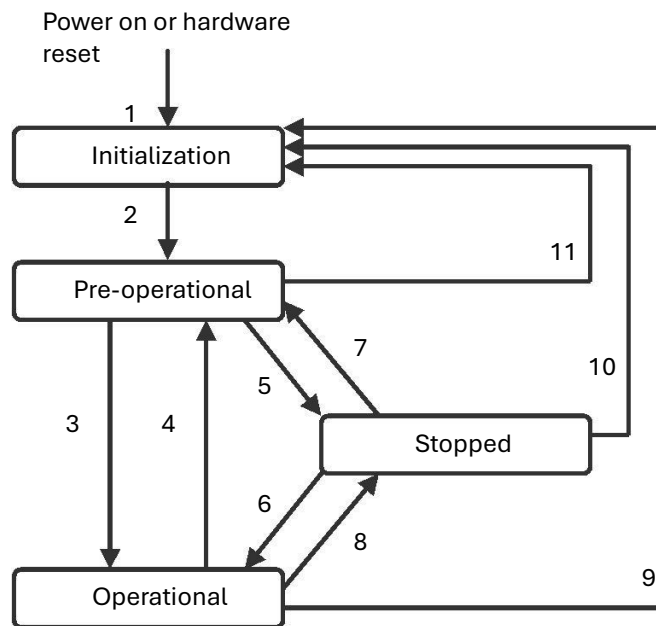

**Figure 2: State diagram of a device**

- 1 At Power on the initialization state is entered autonomously
- 2 Initialization finished - enter **pre-operational** automatically
- 3,6 **Start** remote node
- 4,7 Enter **pre-operational** remote node
- 5,8 **Stop** remote node
- 9,10,11 **Reset** remote node / **Reset communication** of remote node

**Table 7: Trigger for state transition**

	INITIALIZING	PRE-OPERATIONAL	OPERATIONAL	STOPPED
PDO			X	
SDO		X	X	
SYNC		X	X	
EMCY		X	X	
Boot-Up Object	X			
Network Management Objects		X	X	X

**Table 8: NMT states and defined communication objects**

### 2.9.2. Error Control Protocols

Through Error control services the NMT detects failures in the network. Local faults in a node may lead to a reset or change of state. Error Control services are achieved principally through periodically transmitting of COBs by a device.

There exist two possibilities to perform Error Control. The **guarding** is achieved through transmitting guarding requests (Node guarding protocol) by the NMT Master. If a NMT Slave has not responded within a defined span of time (node life time) or if the NMT Slave's communication status has changed, the NMT Master informs its NMT Master Application about that event. The slave uses the guard time and lifetime factor from its Object Dictionary to determine the node life time. If the NMT Slave is not guarded within its life time, the NMT Slave informs its local Application about that event. If guard time and life time factor are 0 (default values), the NMT Slave does not guard the NMT Master. Guarding starts for the slave when the first remote-transmit-request for its guarding identifier is received. This may be during the boot-up phase or later. A slave establishes the **heartbeat** mechanism for a device through cyclically transmitting a message. One or more devices in the network are aware of this heartbeat message. If the heartbeat cycle fails for the slave the local application on the master will be informed about that event. It is not allowed for a slave to use both protocol; in case both are activated the heartbeat protocol will be used.

- Node Guarding Protocol:** The NMT Master polls (with an RTR COB with same COB-ID of the Error Control COB) each NMT Slave at regular time intervals. This time-interval is called the guard time and may be different for each NMT Slave. The response of the NMT Slave contains the state of that NMT Slave. The node life time is given by the guard time (object 100Ch.0h) multiplied by the life time factor (object 100Dh.0h). The node life time can be different for each NMT Slave. If the NMT Slave has not been polled during its life time, it issues an EMCY object with error code 8130h (see §2.8) and then the action indicated in the Abort Connection (object 6007h.0h) is issued. The error is cleared either restarting polling slave or by a reset node / reset communication command.
- Heartbeat Protocol:** It defines an Error Control Service without need for remote frames. The slave transmits a Heartbeat message cyclically. The master receives the indication. The master guards the reception of the Heartbeat within the Producer Heartbeat Time (object 1017h.0h).
- Bootup Protocol:** It is used to signal that a NMT slave has entered the node state PRE-OPERATIONAL after the state INITIALIZING.

#### Error Control COB

COB-ID	B0	
700h+node-ID	7 t	6..0 s

t: used only with the **Node Guarding Protocol**, it toggle between 0 and 1 every time the COB is sent (the first time after boot-up or reset node / reset communication command is 0); other ways is 0

s: 00h: Bootup  
04h: Stopped  
05h: Operational  
7Fh: Pre-Operational

## 3. CANopen for digital motion controller – DSP402

The purpose of this profile is to give drives an understandable and unique behavior on the CAN bus. The purpose of drive units is to connect axle controllers or other motion control products to the CAN bus. At run time, data can be obtained from the drive unit via CAN bus by either polling or event driven (interrupt). The motion control products have a process data object mapping for real time operation. This communication channel is used to interchange real-time data like set-points or present values like a position actual value e.g.

The two principal advantages of the profile approach for device specification are in the areas of system integration and device standardization.

If two independent device manufacturers design products that have to communicate, then both manufacturers must be provided with a device specification from the other one. These specifications will widely differ in formal and terminological



aspects from one company to another. The concept of device profiling provides a standard for producing such specifications. By adopting this approach, all manufacturers will specify their devices in a similar fashion, what greatly reduces the effort involved in system integration.

The other obvious advantage of the profile approach for device specification is, that it can be used to guide manufacturers into producing standardized devices. The advantages of standardized devices are numerous. Perhaps most important is the idea, that a standardized device decouples a system integrator from a specific supplier. If one supplier cannot meet special application demands, a system designer can use devices from another supplier with reduced effort. On the other hand the device manufacturers are not forced any more to implement private protocols for each customer.

A device profile defines a ‘standard’ device. This standard device represents really basic functionality, every device within this device class must support. This mandatory functionality is necessary to ensure, that at least simple non-manufacturer-specific operation of a device is possible. For example the standard drive unit provides a **Quick stop** function to stop a drive. This function is defined as mandatory, such that any drive unit supporting the CANopen Device Profile for Drives and Motion Control, can be halted using the same message.

### 3.1. TWX motion profiles, states, and commands

The basic architecture is composed of two main modules:

- **Device Control:** the state machine executes the starting and stopping of the drive and mode specific commands
- **Modes of Operation:** The operation mode defines the behavior of the drive. The following modes are possible
  - 1) **Profile position mode:** In this mode motor reaches the angular position (absolute or relative) specified by master in the “target position” param. Speed and acceleration parameters are limited by the master (Trajectory Generator). Motion starts when “new set point” controlword is received (param. 6040h)
  - 2) **Profile velocity mode:** This Mode controls the velocity of motor rotation, with no regard of the position. It supplies Trajectory Generation according to the acceleration and deceleration specified in PDO parameters for this profile. Moving starts when a “new set point” controlword is received (param. 6040h), and speed can be changed while motor is working, like in other profiles.
  - 3) **Interpolated position mode:** This mode allow the time interpolation of single axes and the spatial interpolation of coordinated axes. Synch packets are used to coordinate the timing and positions of motors and axes on bus, to reach the requested positions (bypassing speed and acceleration PDO related to ordinary position mode). Motion starts at every Interpolation cycle time (602h param.), to reach the new target position (60C1h param). No “set point” controlword needed, like in PP and PV mode.
  - 4) **Homing mode:** This is the method by which a drive seeks the home position (also called, the datum, reference point or zero point), until external sensor sends the “home reached” signal, typically to the “auxiliary input” of drive power cord (see “wiring” section of this manual).
  - 5) **Cyclic Synchronous Position mode (CSP)** In this mode the the master periodically sends a target position to the drive in accordance with the PDO update cycle, using Synch packets to sincronize the communications. The slave drive use internal interpolation and trajectory generator to reach the target position in the cycle time, before receiving the new target.
  - 6) **Cyclic Synchronous Velocity mode (CSV)** The same of CSP but using velocity target .
  - 7) **Cyclic Synchronous Torque mode (CST)** The same of CSP but using torque target.
  - 8) **Touch Probe Function** In this mode the drive save into PDO the position when is received a rising or falling edge of an external digital signal (e.g AUX input of power cord) typically related to a switch or other sensor.
  - 9) **Rotary table control:** The user could select a position on a positions array (pre-saved into drive’s parameters) by an index (up to 63 positions); the drive will select each time the best route choosing the rotation direction to reach the position requested by master.

The Twx Motor support switching between the various modes of operation, also when the axes is moving.

The operation mode can be changed writing the mode number(1,2,3...) into **parameter 6060h.0h**

### 3.2. Device Control

The device control function block controls all functions of the drive (drive function and power section). The state of the drive can be changed by the controlword (object 6040h.0h) and checked in the statusword (object 6041h.0h). The state machine is controlled externally by the controlword and internally by signals like faults.

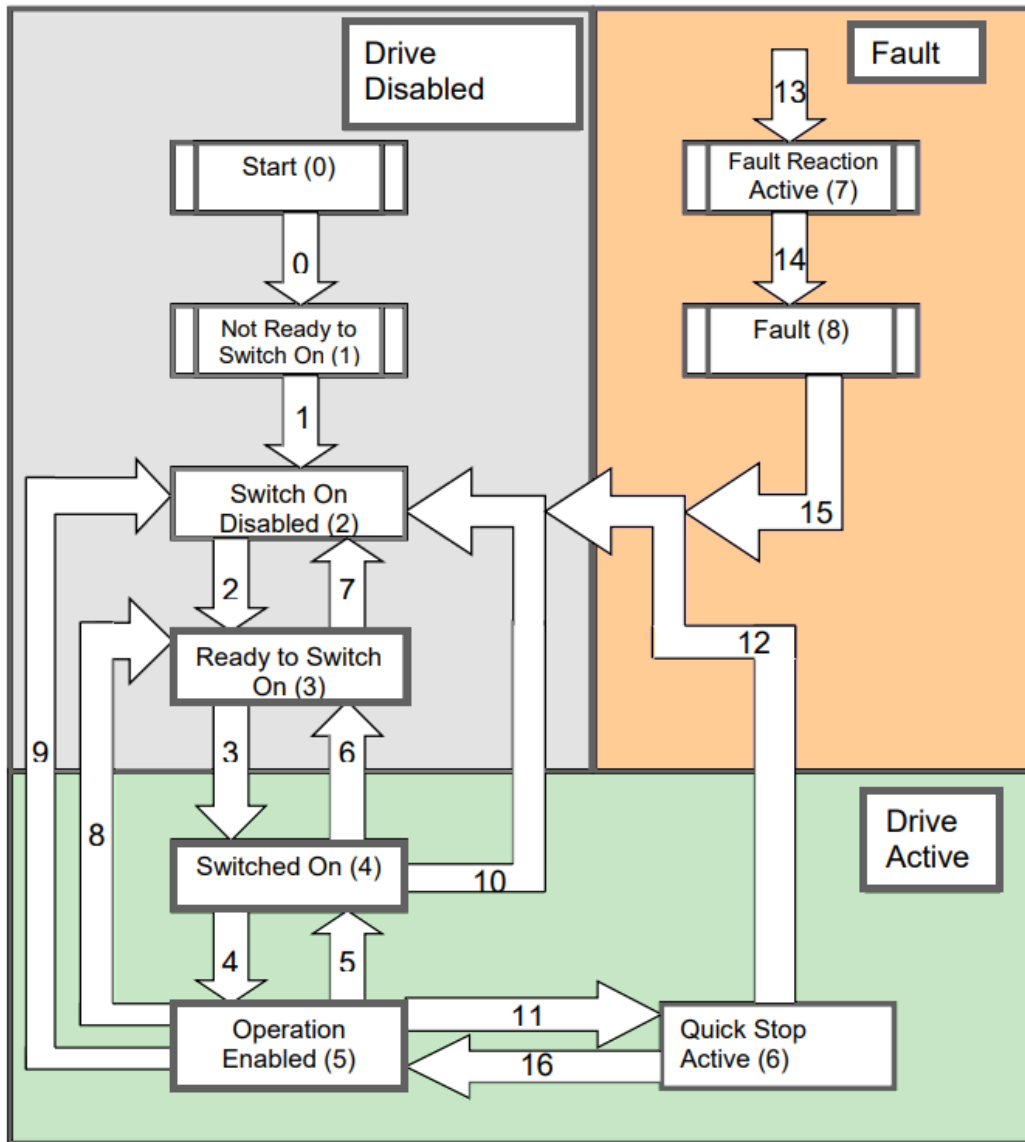

When power output is enabled high voltage switching is applied to the motor phases, torque could be applied or could be null.

State	Statusword	Description
Not Ready to Switch On	xxxx xxxx x0xx 0000	The Twx Motor is being initialized, then is not ready to accept command and the <b>power output is disabled</b>
Switch On Disabled	xxxx xxxx x1xx 0000	Twx Motor initialization is complete, then is ready to accept command, the <b>power output and the drive functions are disabled</b>
Ready To Switch On	xxxx xxxx x01x 0001	The drive functions are disabled, the drive is ready to enable power output
Switched On	xxxx xxxx x01x 0011	The drive functions are disabled, the drive has power output enabled, the motor shaft has no torque
Operation Enable	xxxx xxxx x01x 0111	The drive functions and power output are enabled, the torque could be applied on the motor shaft, no faults detected, specific selected Mode Of Operation is

State	Statusword	Description
		executed
Quick Stop Active	xxxx xxxx x00x 0111	The drive functions and power output are enabled, the quick stop function is being executed or finished and the motor stopped (depending from object 605Ah.0h)
Fault Reaction Active	xxxx xxxx x0xx 1111	The drive functions and power output are enabled, the fault recovering is being executed (defined by the object 605Eh.0h and if not a fatal fault, see <a href="#">Table 6</a> )
Fault	xxxx xxxx x0xx 1000	A fault is occurred in the device, the drive functions and power output are disabled

For complete reference look at statusword (object 6041h.0h)

**Table 9: Drive states**

Transition	Event	Action
0	Reset	Twx Motor internal self-initialization
1	Twx Motor has finished self-initialization	Activate communication
2	Shutdown command	None
3	Switch On command	Enable power output
4	Enable Operation command	The drive functions are enabled and torque could be applied
5	Disable Operation command	The drive functions are disabled, the behaviour of the motor depend from the object 605Ch.0h
6	Shutdown command	Disable power output
7	Quick Stop or Disable Voltage command	None
8	Shutdown command	The drive functions and power output are disabled, the behaviour of the motor depend from the object 605Bh.0h
9	Disable Voltage command	The drive functions and power output are disabled, the motor is free to rotate
10	Disable Voltage or Quick Stop command	The drive functions and power output are disabled, the motor is free to rotate
11	Quick Stop command	The quick stop function is executed, (see object 605Ah.0h)
12	Quick Stop function executed or Disable Voltage command	The drive functions and power output are disabled, the motor is free to rotate
13	A fault is occurred	Execute the appropriate fault reaction (see object 605Eh.0h) if non-fatal fault, see <a href="#">Table 6</a>
14	The fault reaction is completed	The drive functions and power output are disabled, the motor is free to rotate
15	<b>Fault Reset</b> command	Reset of the fault condition; after leaving the state Fault, the bit Fault Reset in the command word has to be cleared by the host
16	<b>Enable Operation</b> command	The drive functions are enabled; the transition is possible according to the object 605Ah.0h

**Table 10: State transition**

Command	Controlword	Hex value	Transition
Shutdown	xxxx xxxx xxxx x110	6h	2,6,8
Switch On	xxxx xxxx xxxx x111	7h	3
Disable Voltage	xxxx xxxx xxxx xx0x	0h	7,9,10,12
Quick Stop	xxxx xxxx xxxx x01x	2h	7,10,11
Disable Operation	xxxx xxxx xxxx 0111	7h	5
Enable Operation	xxxx xxxx xxxx 1111	Fh	4,16
Fault Reset	xxxx xxxx 1xxx xxxx	80h	15
Cyclic Synchronous Position mode	xxxx xxx1 xxxx xxxx	100h	
Cyclic Synchronous Velocity mode	xxxx xx1x xxxx xxxx	200h	

**Table 11: Commands in the controlword**

For complete reference look at controlword (object 6040h.0h)

The drive functions depend from the selected mode of operation (object 6060h.0h), that could be checked reading the mode of operation display (object 6061h.0h); this selection also modifies the behaviour of some bits of the controlword and the statusword. The specific drive function is executed only when the drive status is **Operation Enabled**.

Refer to §6.2 and to §6.3 for examples on how to use the controlword.

- 6040h.0h: Controlword
- 6041h.0h: Statusword
- 605Bh.0h: Shutdown option code
- 605Ch.0h: Disable operation option code
- 605Ah.0h: Quick stop option code
- 605Eh.0h: Fault reaction option code

- 6060h.0h: Modes of operation
- 6061h.0h: Modes of operation display
- 6085h.0h: Quick stop deceleration

**Table 12: Device Control related objects**

### 3.3. Profile Position Mode

A target position (object 607Ah.0h) is applied to the trajectory generator; it generates a position demand value (object 6062h.0h) that is feed as reference position to the internal speed loop. These two function blocks are controlled by individual parameter set.

The trajectory generator support only linear ramp (trapezoidal profile), with separate parameters for acceleration (object 6083h.0h) and deceleration (object 6084h.0h), velocity profile (object 6081h.0h) All those parameters could also be changed during positioning: the trajectory generator will always follows the new rules; for example, if you change velocity profile parameter, the drive will reach the new speed using the profile acceleration or deceleration.

This mode is driven by specific bits of the controlword and the statusword, as follow:

Command	Controlword	Description
New Set Point	xxxx xxxx xxx1 xxxx	Switching from 0 to 1 starts new target positioning
Change Set Immediately	xxxx xxxx xx1x xxxx	If 0 the new positioning is started after finish of the current positioning, if 1 the new positioning interrupt the current positioning
Abs / rel	xxxx xxxx x1xx xxxx	If 0 the target position is an absolute value, if 1 is a relative value (incremental)
Halt	xxxx xxx1 xxxx xxxx	Stop the motor with the profile deceleration (depend from the object 605Dh.0h); on reset resume the interrupted positioning

For complete reference look at controlword (object 6040h.0h)

**Table 13: Profile position commands**

State	Statusword	Description
Target Reached	xxxx x1xx xxxx xxxx	The target position is reached (see object 6067h.0h and object 6068h.0h) or, if an halt command is issued, the velocity of the motor is zero
Set Point Acknowledge	xxx1 xxxx xxxx xxxx	Trajectory generator has assumed the new target position
Following Error	xx1x xxxx xxxx xxxx	Following error, the thresholds are defined in the objects 6065h.0h and 6066h.0h

For complete reference look at statusword (object 6041h.0h)

**Table 14: Profile position status**

First of all the target position have to be loaded with the desired value, then the **New Set Point** bit has to be set; the drive signal the acquisition (and then the execution of the movement) of the target position setting the **Set Point Acknowledge** bit. Resetting the **New Set Point** also reset the **Set Point Acknowledge**, this operation does not affect the current positioning. Now a new target position could be loaded and signaled via **New Set Point** to the drive: if the previous targeting is not completed the drive will keep **Set Point Acknowledge** low until target is reached (signaled in the statusword), then it go high and the drive start the new positioning. If **Change Set Immediately** is set together with the **New Set Point**, then the new positioning is started immediately, still respecting the trajectory generator parameters.

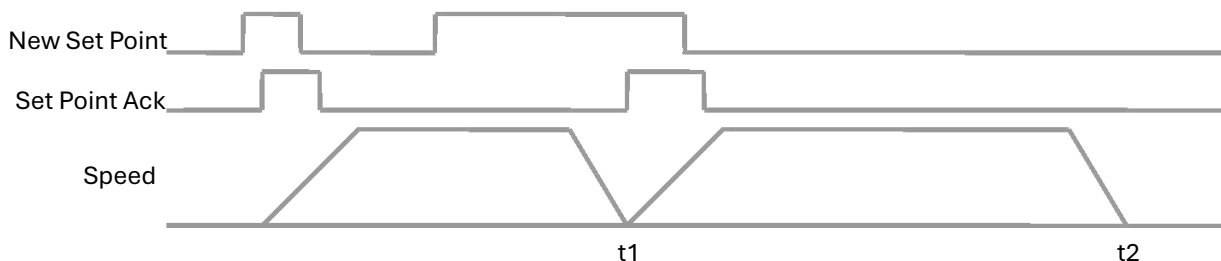

**Figure 4: Single set point**

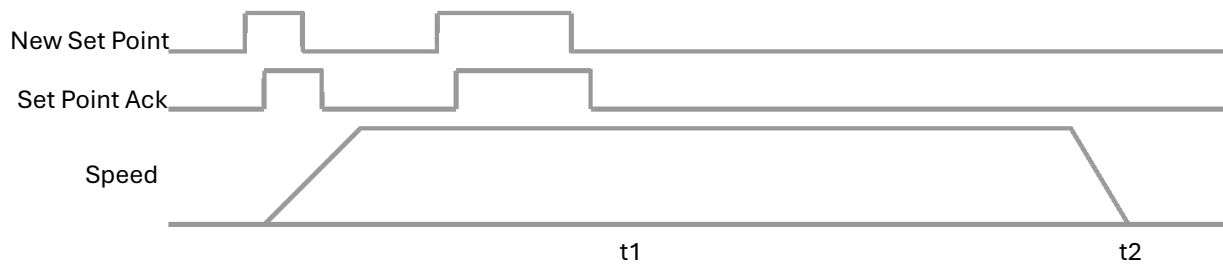

**Figure 5: Change set immediately set point**

If **Abs / rel** is set together with **New Set Point** then the target position is treated as an signed increment of the present target position.

Symmetrically around the target position a window (object 6067h.0h) is defined for the accepted position range, that is  $target\ position \pm position\ window$ . If a drive is situated (object 6064h.0h) in the accepted position range over the time position window time (object 6068h.0h) the **Target Reached** bit is set.

A following error window (object 6065h.0h) is defined for the accepted following error tolerance. If the modulus of the following error actual value (object 60F4h.0h) is greater than the following error window for more than following error time out (object 6066h.0h) then the **Following Error** bit is set.

Refer to §6.2 and to §6.3 for examples on profile position mode.

- 6040h.0h: Controlword
- 6041h.0h: Statusword
- 605Dh.0h: Halt option code
- 607Ah.0h: Target position
- 607Dh: Software position limit
- 6081h.0h: Profile velocity
  
- 6083h.0h: Profile acceleration
- 6084h.0h: Profile deceleration
- 6086h.0h: Motion profile type
- 6062h.0h: Position demand value
- 6064h.0h: Position actual value
- 6065h.0h: Following error window
- 6066h.0h: Following error time out
- 6067h.0h: Position window
- 6068h.0h: Position window time
- 60F4h.0h: Following error actual value

**Table 15: Profile Position Mode related objects**

### 3.4. Profile Velocity Mode

When controlword is set in “Enable Operation” (000Fh), the target velocity (object 60FFh.0h) is applied to the trajectory generator; it generates a linear growing velocity demand (object 606Bh.0h) according with acceleration parameter that become reference speed to the internal speed loop.

The trajectory generator support only linear ramp (trapezoidal profile), with separate parameters for acceleration (object 6083h.0h) and deceleration (object 6084h.0h).

This mode is driven by specific bits of the controlword and the statusword, as follow:

Command	Controlword	Description
Halt	xxxx xxx1 xxxx xxxx	Stop the motor with the profile deceleration (depend from the object 605Dh.0h)

For complete reference look at controlword (object 6040h.0h)

**Table 16: Profile velocity commands**

State	Statusword	Description
Target Reached	xxxx x1xx xxxx xxxx	The target velocity is reached (see object 606Dh.0h and object 606Eh.0h) or, if an halt command is issued, the velocity of the motor is zero
Speed	xxx1 xxxx xxxx xxxx	The speed is equal to zero (see object 606Fh.0h and object 6070h.0h)

For complete reference look at statusword (object 6041h.0h)

**Table 17: Profile velocity status**

The **Target Reached** bit is set when the modulus difference between the velocity demand value and the velocity actual value (object 606Ch.0h) is within the velocity window (object 606Dh.0h) longer than the velocity window time (object 606Eh.0h).

The **Speed** bit is reset as soon as the velocity actual value exceeds the velocity threshold (object 606Fh.0h) longer than the velocity threshold time (object 6070h.0h). Below this threshold the bit is set and indicates that the axle is stationary.

Refer to §6.2 and to §6.3 for examples on profile velocity mode.

- 6040h.0h: Controlword
- 6041h.0h: Statusword
- 605Dh.0h: Halt option code
- 6083h.0h: Profile acceleration
- 6084h.0h: Profile deceleration
- 6069h.0h: Velocity sensor actual value
- 606Bh.0h: Velocity demand value
- 606Ch.0h: Velocity actual value
- 606Dh.0h: Velocity window
- 606Eh.0h: Velocity window time
- 606Fh.0h: Velocity threshold
- 6070h.0h: Velocity threshold time
- 60FFh.0h: Target velocity

**Table 18: Profile Velocity Mode related objects**

### 3.5. Interpolated position Mode

The interpolated position mode is used to control multiple coordinated axes or a single axle with the need for time-interpolation of set-point data. The interpolated position mode uses the SYNC (see §2.7) as the time synchronization mechanism for a time coordination of the related drive units.

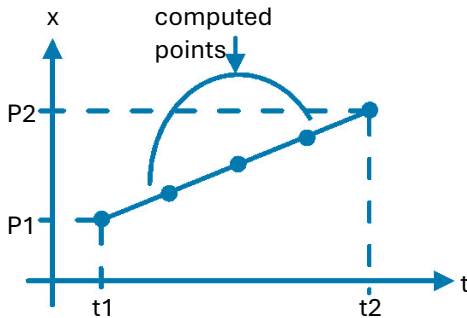

The interpolation data record contains the interpolation data; Twx Motor supports only synchronous operation and linear interpolation, thus the data record has only one field, the position set-point (object 60C1h); the interpolation time period (object 60C2h) is referred to the ip sync period. The ip sync is the event that triggers the execution of the set-point data, the SYNC is the physically COB on the network and trigger the sync PDO.

To ensure proper operations, the interpolation data should be supplied continuously in real time via PDO (see §2.6), one set-point per ip sync for the calculation of the next demand value. For each interpolation cycle, the drive will calculate a position demand value (at every internal cycle time that is 250µs) by interpolating positions over a period of time. The position demand value is feed directly as input of the speed loop, bypassing the trajectory generator and thus neglecting all velocity and acceleration limitations.

Optionally the set-points could be iterated across a 2 order digital filter (see §4.7).

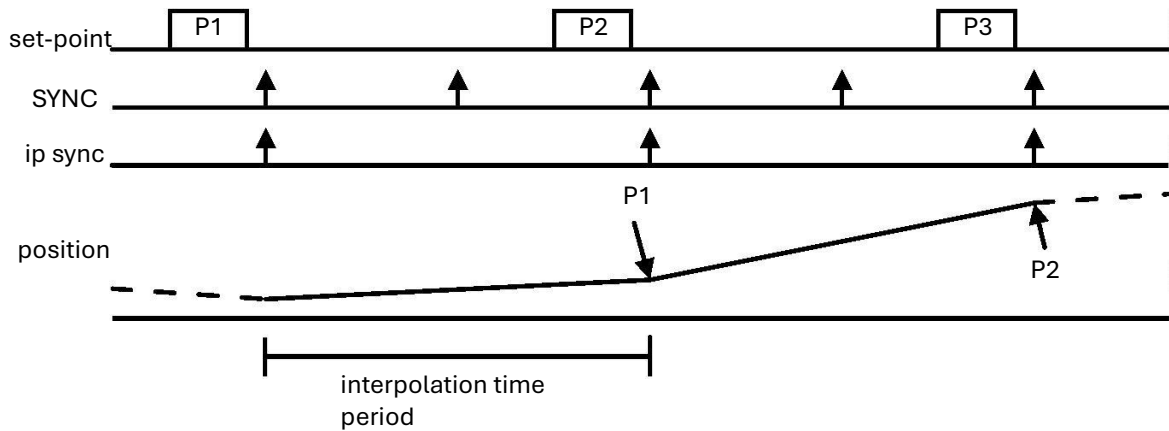

**Figure 6: Interpolation with ip sync every 2 SYNC**

This mode is driven by specific bits of the controlword and the statusword, as follow:

Command	Controlword	Description
Enable ip mode	xxxx xxxx xxxx 1xxx	Enable operations controlword enables IP mode as in profile velocity
Halt	xxxx xxx1 xxxx xxxx	Stop the motor with the profile deceleration (depend from the object 605Dh.0h)

For complete reference look at controlword (object 6040h.0h)

**Table 19: Interpolated position commands**

State	Statusword	Description
Target Reached	xxxx x1xx xxxx xxxx	The target position is reached or, if an halt command is issued, the velocity of the motor is zero
Ip mode active	xxx1 xxxx xxxx xxxx	Axes movement active

For complete reference look at statusword (object 6041h.0h)

**Table 20: Interpolated position status**

To have an accurate start-up condition, it is suggested to map the controlword (object 6040h.0h) in one sync PDO and then use it to give the drive the **Enable ip mode**; in this way only the following SYNC will start triggering the ip sync, apart when drive has began receiving the SYNC.

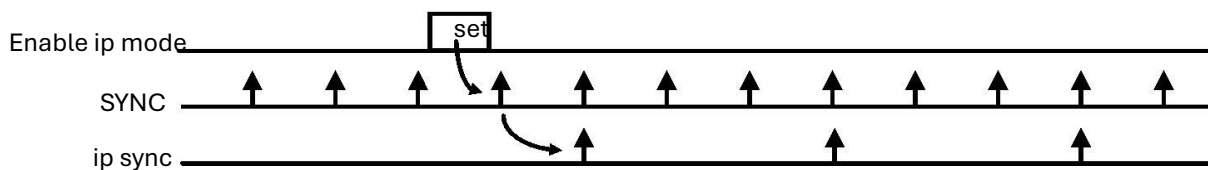

**Figure 7: Interpolation start-up synchronization (ip sync every 3 SYNC)**

- 6040h.0h: Controlword
  - 6041h.0h: Statusword
  - 605Dh.0h: Halt option code
  - 607Dh: Software position limit
  - 60C1h: Interpolation data record
  - 60C2h: Interpolation time period
  - 60C3h: Interpolation sync definition
  - 6062h.0h: Position demand value
  - 6064h.0h: Position actual value
  - 60F4h.0h: Following error actual value
  - 5309h: Position set-point filter
- Table 21: Interpolated Position Mode related objects

### 3.6. Homing Mode

This is the method by which a drive seeks the home position (also called, the datum, reference point or zero point). There are various methods of achieving this, all of them use a home switch (zero point switch) in mid-travel. The home switch must be connected to the auxiliary digital input (see §4.6), no additional configuration for this input has to be done.

The user can specify an homing speed(obj 6099h), an homing acceleration (obj 609Ah) and an homing method (obj 6098h), that will be used throughout all the procedure.

The successfully completed procedure will be signalled by the **Homing done** bit in the statusword (object 6041h.0h).

In order to start seeking of home position, the **Home operation start** bit has to be set. If the selected method is not supported, the **Homing error** bit will be activated; otherwise the **Homing attained** bit activation will signal the successfully end of homing procedure and the zero speed of the motor. Now **Home operation start** bit could be reset.

This mode is driven by specific bits of the controlword and the statusword, as follow:

Command	Controlword	Description
Homing operation start	xxxx xxxx xxx1 xxxx	The transition 0→1 start the homing, the transition 1→0 interrupt the homing
Halt	xxxx xxx1 xxxx xxxx	Stop the motor with the profile deceleration (depend from the object 605Dh.0h); the homing procedure will restart from the beginning

For complete reference look at controlword (object 6040h.0h)

**Table 22: Homing commands**

State	Statusword	Description
Homing attained	xxx1 xxxx xxxx xxxx	Homing mode carried out successfully, motor is stopped
Homing error	xx1x xxxx xxxx xxxx	The selected method is not supported. This flag is activated when <b>Homing operation start bit is activated</b>
Homing done	1xxx xxxx xxxx xxxx	The homing is done, this bit remain active up to a node reset or a power-off

For complete reference look at statusword (object 6041h.0h)

**Table 23: Homing status**

- 6040h.0h: Controlword
- 6041h.0h: Statusword
- 605Dh.0h: Halt option code
- 607Ch.0h: Home offset
- 6098h.0h: Homing method
- 6099h: Homing speeds
- 609Ah.0h: Homing acceleration

**Table 24: Homing Mode related objects**



**3.6.1. Homing methods 19 and 20**

The initial direction of the movement is dependent on the state of the home switch. The home position is on the point where the home switch changes its state. The point at which the reversal direction of movement takes place is anywhere after the change of state of the home switch.

The seeking ends on high to low home switch transition and counterclockwise movement direction (19) or on low to high home switch transition and clockwise movement direction (20).

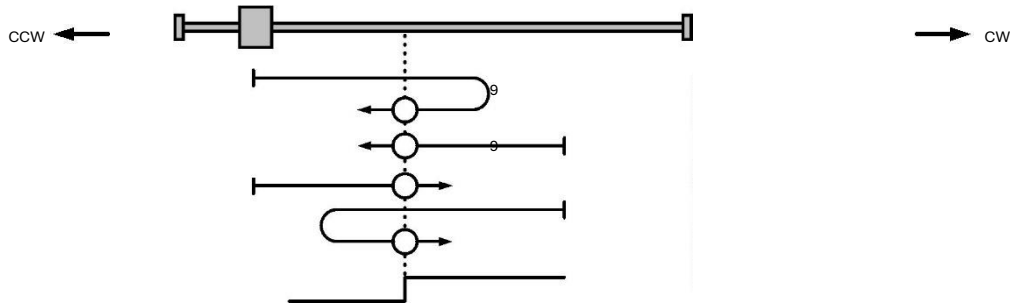

Home switch state

**Figure 8: Homing method 19 and 20**

**3.6.2. Homing methods 21 and 22**

The initial direction of the movement is dependent on the state of the home switch. The home position is on the point where the home switch changes its state. The point at which the reversal direction of movement takes place is anywhere after the change of state of the home switch.

The seeking ends on high to low home switch transition and clockwise movement direction (21) or on low to high home switch transition and counterclockwise movement direction (22).

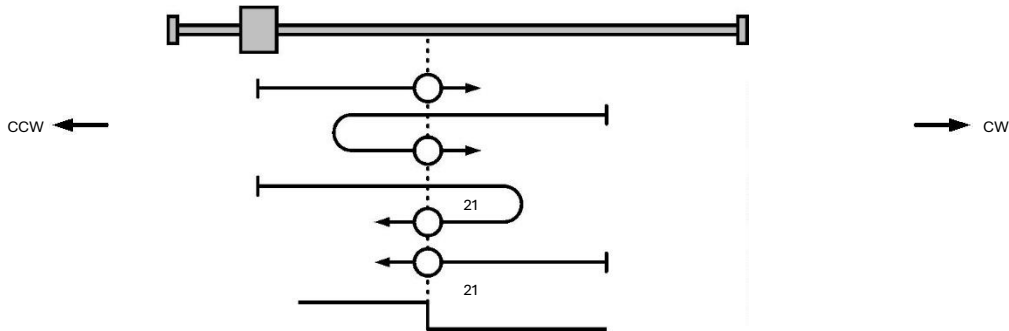

Home switch state

**Figure 9: Homing method 21 and 22**

**3.6.3. Homing methods 26 and 30**

These methods detect the transition high to low of the home switch as home position; if the home switch is low on starting, the drive ignore it and wait for the transition. The direction of the movement is clockwise (26) or counterclockwise (30).

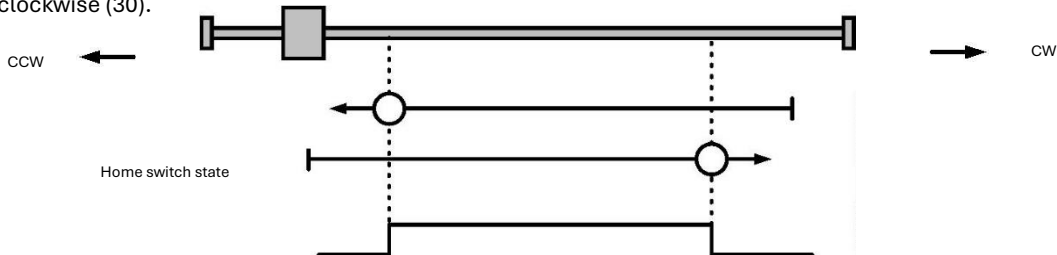

Home switch state

**Figure 10: Homing method 26 and 30**

### 3.7 Rotary table mode

The user could select a position on a rotary table by an index (up to 126 positions). The positions are indexed by a target index (object 5323h.0h), user has to download all the absolute positions in the table positions array (object 5320h). It is possible to specify a gear play compensation (object 5322h.0h) to achieve a better accuracy on the positioning; the compensation is done only when the direction of rotation is counterclockwise by subtracting from the target position the desired over-travel.

Three possibilities exist for the rotary table positioning:

- Absolute with best-route selection: the drive compute the shortest route to reach the target, by choosing clockwise or counterclockwise rotation
- Absolute positioning: the sign of the target index determines the rotation direction
- Relative positioning: the signed target index is added to actual target (and wrapped, if necessary), the sign determines the rotation direction

When rotary table mode is activated:

- **An homing cycle is required** to find the machine zero point (absolute encoder property will not be used)
- **Actual position** (obj 6064h) value, when homing is completed, is stored into **home offset** (obj 607Ch), and its value is subtracted from the previous absolute position. So actual position become 0
- **Table actual position** (obj 5324h) become 0 as well

The drive use the position actual value (object 6064h.0h) to check if wrapping of **Table actual position** has to be done or not (bring that to 0 when exceed the table dimension (obj 5321h); when this object reach the boundary it is possible that other position objects (e.g. the position demand value) falls outside the boundary.

In this case a new homing procedure is necessary to reset at zero point the actual position value.

This mode is driven by specific bits of the controlword and the statusword, as follow:

Command	Controlword	Description
Absolute best-route	xxxx xxxx x001 xxxx	Absolute positioning with best-route
Absolute positioning	xxxx xxxx x011 xxxx	Absolute positioning without best-route
Relative positioning	xxxx xxxx x1x1 xxxx	Relative positioning
Halt	xxxx xxx1 xxxx xxxx	Stop the motor with the profile deceleration (depend from the object 605Dh.0h); on reset resume the interrupted positioning

For complete reference look at controlword (object 6040h.0h)

**Table 28: Rotary table commands**

State	Statusword	Description
Warning	xxxx xxxx 1xxx xxxx	Something prevent the positioning, see in the following text
Target Reached	xxxx x1xx xxxx xxxx	The target position is reached (see object 6067h.0h and object 6068h.0h) or, if an halt command is issued, the velocity of the motor is zero
Set Point Acknowledge	xxx1 xxxx xxxx xxxx	Trajectory generator has assumed the new target index

For complete reference look at statusword (object 6041h.0h)

**Table 29: Rotary table status**

Issuing the control word immediately start the positioning, this is signalled by the **Set Point Acknowledge** bit that remain active until user reset the command bits in the controlword. Once started, the positioning could be cancelled only using either halt or quick stop or device controls commands. If the **Warning** bit is issued in place of the **Set Point Acknowledge** then some of the following reason prevent the positioning:

- 040h.0h: Controlword      041h.0h: Statusword
  - 081h.0h: Profile velocity
  - 083h.0h: Profile acceleration    084h.0h: Profile deceleration
  - 067h.0h: Position window    068h.0h: Position window time
  - 320h: Table positions array
  - 321h.0h: Table dimension / Rotary axis dimension
  - 322h.0h: Gear play compensation
  - 323h.0h: Rotary table target index
  - 380h.0h: Global option flags
- Table 25: rotary table related objects

### 3.8. Cyclic Synchronous Position Mode (CSP Mode)

With this mode, the trajectory generator is located in the control device, not in the drive device.

In cyclic synchronous manner, it provides a target position to the drive device, which performs position control, velocity control and torque control. Measured by sensors, the drive provides actual values for position, velocity and torque to the control device.

This mode is almost identical with Linear interpolation mode, only that it receives its position data into 607Ah instead of 60C1h sub-index 01. No interpolation point buffer will be used.

Interpolation period time in object 60C2h is used as synchronization period.

#### Interpolation time period

The Interpolation time period (object 60C2h) indicates the configured interpolation cycle time. Its value must be set with the time value of the CANopen master communication cycle time and sync time in order for the Cyclic Synchronous Position mode to work properly.

Remark: due to the limitations of the CAN network, it is recommended that the interpolation time period should not be set lower than 4 ms.

#### Controlword in Cyclic Synchronous Position mode (CSP)

The drive must be in Operation Enable state (controlword 6040h set to 000Fh) to operate in this mode.

#### Statusword in Cyclic Synchronous Position mode (CSP)

Bit n.12 bit stays on 1 as long as the drive is following the position set-points

Bit n.13 indicates Following error

#### Maximum velocity in CSP mode

The maximum velocity, object 6081h, is used in CSP as in the position profile mode.

### 3.9. Cyclic Synchronous Velocity Mode (CSV Mode)\*

This profile works like CSP mode, but the drive controls here the motor speed instead of position.

CSV mode uses target velocity (object 60FFh), received at synchronization period by control device (master).

CSV mode use same objects of profile velocity mode: Profile acceleration, Profile deceleration, Scaling,

#### Controlword in Cyclic Synchronous Position mode (CSP)

The drive must be in Operation Enable state (controlword 6040h set to 000Fh) to operate in this mode.

#### Statusword in Cyclic Synchronous Position mode (CSP)

Bit n.12 bit stays on 1 as long as the drive is following the position set-points

\*CSV mode supports changes to the velocity setpoint using PDO methods only.

The setpoint will not respond to SDO methods.

## 4. Auxiliary input (Aux In) configuration

In CockpitLT it is possible to configure TWX behavior when the “AUX input” of power cord is (or triggers) on High or Low value. Possible values are listed on a drop down menu like in the cockpitLT window screenshot shown below.

In this way it is possible to obtain a fieldbus independent safety function that disable voltage to the motor, similar e/o complementary to **Safe Torque Off**, or in alternative a **Quick Stop** function as well that stops the motor instead of simply cutting the power (and so the torque).

Name	Device Value	Config Value	Unit	Description
sLegacy		{{{24576,4096,32,0,0,30720,0,0,3...		
sMotor		{{{0,00000,0,0,0,0,0}},{{{0,00,0,0}},{0...		
sBridge		{{{+0,00,+0,00,+0,00}},{{{0,00}},{0,0,0...		
sController		{{{+0,00,+0,00}},{{{20,0000,10000,0,...		
sEncResolver0		{{{Off,0,00000}},{{{0,0,00000,0,000...		
sEncDigital0		{{{{{0,0,00000,0,00000}},0,{{{0,00000...		
sFieldBus		{{{10,0000,0,0100000,0,0250000}},...		
sDriveProfile		{0000,0000,0000,eDCAbort_NoA...		
sDriveProfile.sDeviceControl		{0000,0000,0000,eDCAbort_NoA...		Device control FSA
sDriveProfile.sInterpolation		{{0},{1,-3}}		Interpolation related objects
sDriveProfile.sControl		{0000}		Generic device control
sDriveProfile.sPosition		{0,23068672,{-2147483647,2147...		Position related objects
sDriveProfile.sHoming		{0,0,{23068672,2306867},4096,{e...		Homing related objects
sDriveProfile.sTouchProbe		{0000,0000,0,0,0,0}		Touch probe related objects
sDriveProfile.sVelocity		{0,4096,4096,16384,0,0,1310720,...		Velocity related objects
sDriveProfile.sTorque		{0,10000,0,0,0}		Torque related objects
sDriveProfile.sRotaryTable		{0,0,0,{0,0,0,0,0,0,0,0,0,0,0,0,...		Rotary table related objects
sDriveProfile.sDigitalInputsOptCodes		{eDigInp_NoAction,eDigInp_NoAc...		Digital inputs option codes
diginp0	eDigInp_NoAction	eDigInp_NoAction		Digital input #0
diginp1	eDigInp_NoAction	eDigInp_NoAction		Digital input #1

Configuring Aux Input action using CockpitLT commissioning tool.

## 4. Special command/events reaction configuration

Through cockpitLt it is possible to configure different motor reactions or behavior after each of following commands/events

Event	Possible reactions
Abort	Fault signal   disable voltage   quick stop
Quick stop	Disable drive   slow down and disable   quickstop and disable, scurrentlimit and disable, vtagelimit and disable, slow down and stay   quick stop and stay, currentlimit and stay, vtagelimit and stay
Shut down	Disable drive   shutdown and disable
Disable operation	Disable drive   slowdown and disable
Halt	Slow down and stay, quick stop and stay
Fault	Disable drive   slowdown   quick stop, current limit, voltage limit

Name	Device Value	Config Value	Unit	Description
sDriveProfile.sDeviceControl		{0000,0000,0000,eDCAbort_Fault...		Device control FSA
supporteddrivemodes		0000		6502h: Supported drive modes
controlword		0000		6040h: Controlword
statusword		0000		6041h: Statusword
abortoptioncode		eDCAbort_FaultSignal		6007h: Abort connection option code
quickstopoptioncode		eDCQuickStop_QuickStopAndDis...		605Ah: Quick stop option code
shutdownoptioncode		eDCShutdown_DisableDrive		605Bh: Shutdown option code
disableoperationoptionc...		eDCDisable_SlowDownAndDisable		605Ch: Disable operation option code

## CockpitLT – USB Commissioning and Diagnostic Software



PhaseMotion Control supplies a *free Realtime Diagnostic and Commissioning Software*, connecting via USB to multiple USB motors.

*No DCBUS or FieldBus connections are required.*

- Download CockpitLt from [www.phase.eu/download/cockpitt/](http://www.phase.eu/download/cockpitt/) (Windows 32 o 64bit)
- Download CockpitLT manual from [www.phase.eu/integrated-servo-drive-twx/twx-manual/](http://www.phase.eu/integrated-servo-drive-twx/twx-manual/) or use the online version, with *real time web chat support*.

After installing, just launch the application and follow the easy procedure to create a project, auto detect connected drive, and browse through status, alarms, and parameters.

Below is a typical window of the CockpitLT software connected to a TWX motor

The intuitive real time interface allow to

- view actual drive status informations, alarms, parameters and PDO
- update writable PDOs,
- write and send controlword PDO, so to move the motor according to the selected profile (position, velocity, torque..etc) just like normal conditions where a fieldbus is used to send commands (if an active DCBUS is connected to the motor).
- update the drive firmware

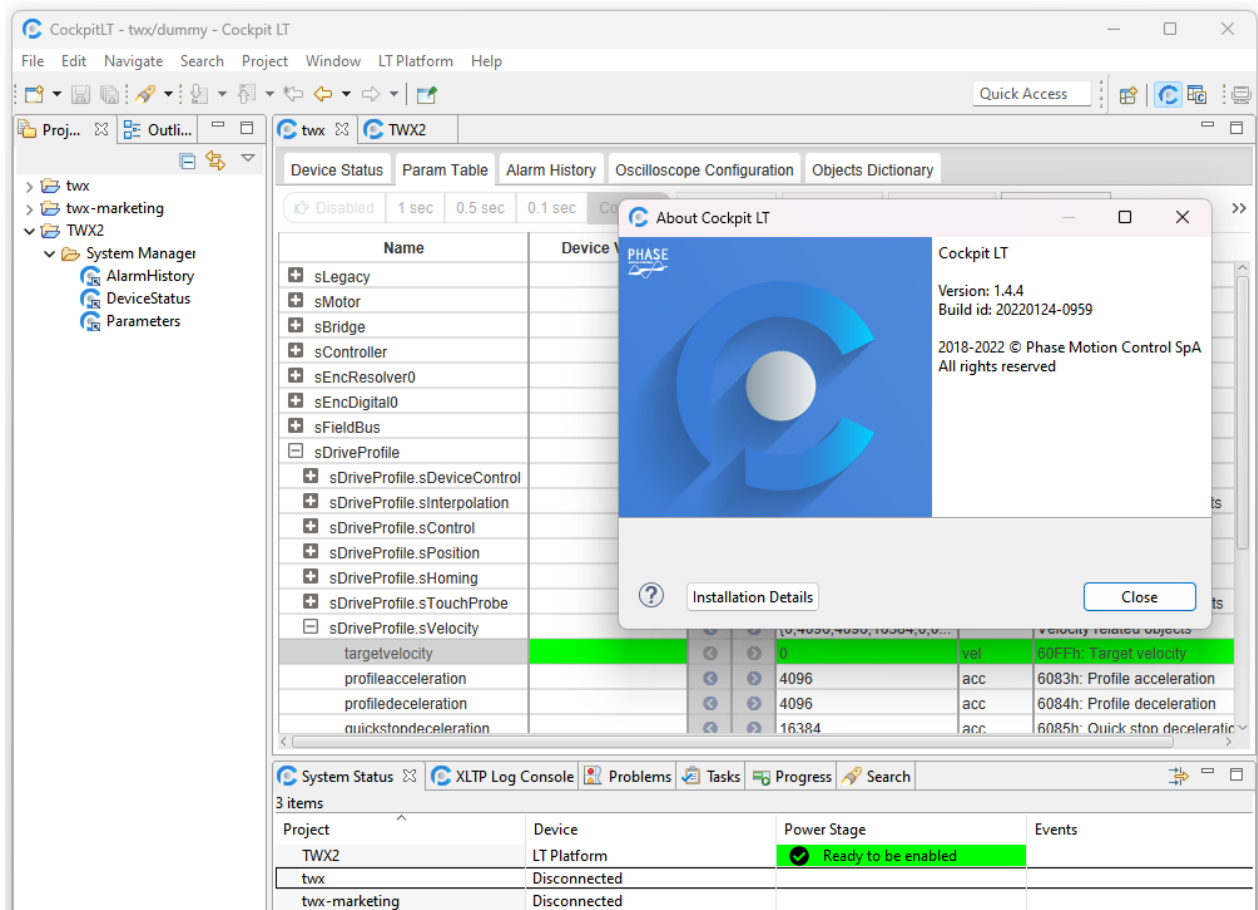

## 4.4. Brake configuration (optional)

If the TWX motor is equipped with optional brake, using CockpitLt it is possible to choose if the brake is activated :

- automatically by the integrated drive (selecting “auto” value in *Command* parameter)
- manually by the Master via fieldbus (selecting “manual” value in *Command* parameter)

Just navigate in the parameters three section: *sController* -> *sController.sHoldBrake* to find the *Command* parameter.

If you choose *manual* as command option, the brake locks setting to 0 the 4010h parameter, and unlocks setting it to 1.

The brake can be activated/deactivated just with +24 voltage supply (no DCbus needed)



The optional TWX brake is a parking brake and cannot be used as a safety device. The activation of STO function can be dangerous in case of suspended loads or in case of high inertia loads. In these cases Phase Motion Control suggests to install a dedicated safety brake operated by a safety system following the applicable safety regulations.

Name	Device Value	Config Value	Unit	Description
sController.sHoldBrake		{5.00000,70,70,Auto,0}		
lockspeed		5 00000	rad/sec	Max speed for brake locking
timerelease		70	msec	Time to release
timelock		70	msec	Time for lock
command		auto		Command mode
control		0		4010h: Control command: 1 => unlock, any other value => lock

## 4.5. Speed loop control

In the Twx drives the speed loop control act both as closed loop position control and closed loop speed control; in the first case the position demand generated by the trajectory generator or by the interpolator is fed to the input of the closed loop; in the second case the speed demand is integrated, thus generating a position demand to be fed to the input of the closed loop.

Then the position demand is optionally limited, in order to keep the absolute value of the position error below an user specified value; this function, jointly with the output speed loop current limit, allow the shaft to run at different speed than the demanded value when an external torque greater than the limit is applied, without saturating the closed loop.

After that the position demand value is filtered, then differentiate two times to obtain the speed reference value and the acceleration reference value.

The encoder position value is optionally sign-inverted and/or offset, giving the user the ability to choose which rotating direction the shaft should move giving incrementing position (or positive velocity) and to select the preferred zero position. The user could choose which appliance comes first, sign-inversion or offset.

Then the resulting value is differentiate two times to obtain the speed feedback value and the acceleration feedback value.

Now all the reference and feedback values go into the closed loop regulator, which is combined with different gains; one is for the position error, one for each speed and one for each acceleration. By default the gain for the speed value is the same for the reference and the feedback (in favour of the compatibility with the old applications), resulting in a gain for the speed error. With the acceleration reference gain the user could reduce the following error during acceleration and deceleration stages. Then the sum is fed into a limited integrator block and the output is added to the previous sum, giving the output value of the closed loop regulator. Now this value is optionally filtered, magnitude (of power of 2) scaled and limited, then it is fed as input of the current closed loop regulator.

The speed loop control is updated at 4 khz.

For further information refer to Appendix A and to §4.1.

### 4.5.1. Performance measurements

In order to have some feedback from the drive about the speed loop control performance, five parameters are provided, as follow.

The following error at maximum speed (object 5120h.0h) is measured at the beginning of the deceleration ramp: this value is useful in those applications in which the position error during movement is crucial, like flying cutting machine. For ordinary positioning this value could be ignored.

In order to get faster positioning, e.g. reducing the time the drive enter and stay in the position window, three measurements are employed. The overshoot at the end of the deceleration ramp (object 5123h.0h) give a measure of the position error at the time in which the motor theoretically should be in the target position; reducing this error is a good starting point to reduce the positioning time. The position window entering time (object 5122h.0h) tell how much time is spent from the end of the deceleration ramp until the position error remain stable inside the position window, thus setting the target reached bit. The maximum overshoot from the end of the deceleration ramp (object 5121h.0h) is the maximum value reached from the position error entering in the position window: higher gain on the control loop could shift the system to the instability, giving high values on this measurement and rising positioning time; on the opposite end, lower gain give a very stable but slow system, giving low values on this measurement and again rising positioning time.

The average windings current (object 5124h.0h) tells if the long time machine cycle could lead in a overtemperature of the system: this value should stay below the datasheet continuative current. This measurement is done with a long time constant, thus giving reliable values after long time running (e.g. 1 hour).

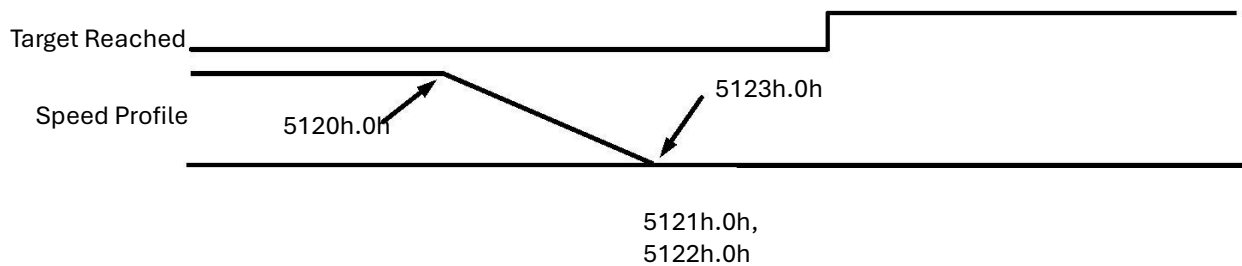

**Figure 11: Control loop performance measurements**

## 4.9. Firmware upgrade

New firmware or firmware updates can be periodically released from Phase Motion Control.

New firmware must be downloaded from the official Phase Motion Control website at the following address [www.phase.eu/integrated-servo-drive-twx/twx-firmware-eds/](http://www.phase.eu/integrated-servo-drive-twx/twx-firmware-eds/) and easily install to drive via USB, using CockpitLT tool.

Just right click on the device in System status list, select Firmware Update item, and select new file from PC.

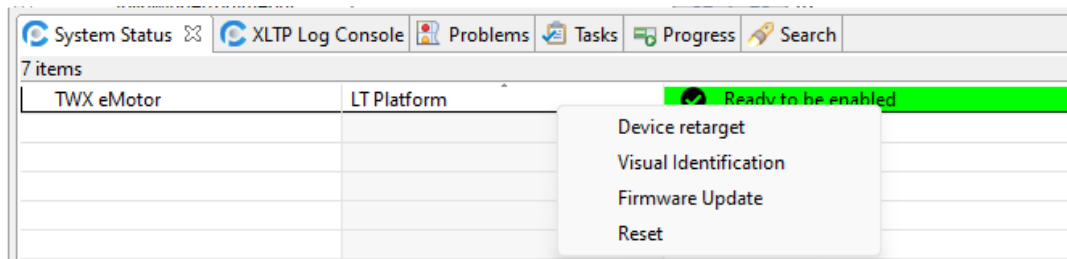

New firmware installation can be verified by the Device Status tab on CockpitLt

Device Status	
<div style="display: flex; justify-content: space-between;"> <span>Param Table</span> <span>Alarm History</span> <span>Oscilloscope Configuration</span> <span>Objects Dictionary</span> </div>	
<b>Device Info</b>	
Name	
Device Name	TWX0503A.30.2N100PCK100
Application UUID	3A0C640D7F47435688B432CD302F8F0A
Application Info Name	CIA DSP402 Motion Control
Param Table Signature	B672597557FCB4D0368E6E143A0615EF
Param Table Defaults Signature	81228553721179F6E2539BE23173D230
Device Serial	10081501
Application Info Name	CIA DSP402 Motion Control
Friendly Name	LT Platform
Recovery Version	V1.7.4
Protocols List	127, 1, 3, 4, 2, 5
Platform Options	-mthumb -mcpu=cortex-m4 -mfloat-abi=hard -mfpu=fpv4-sp-d16 -mlittle-endian
Firmware Running Target	charlie
Firmware Sub Target	core
Firmware Version	V1.7.4
Firmware Verbose	LT charlie.core V1.7.4 Thu, 9 Feb 2023 11:50:47 UTC
Firmware Signature	42653D19185504C656FF9457FE10DA97



## 5. Object Dictionary ref. (5.1 Communication Objects + 5.2 Profile Specific Objects)

The complete Twx Motor object dictionary objects are listed here. For each object there is a set of attributes, as follow:

<i>Object</i>	This is the object index and sub-index, and the name of the parameter
<i>Object Code</i>	Kind of the object: <b>var</b> is single value, <b>array</b> is multiple value with same basic data type, <b>record</b> is multiple value where data fields could be any data type combination
<i>Data Type</i>	Could be <b>integer8</b> (signed 8 bit), <b>integer16</b> (signed 16 bit), <b>integer32</b> (signed 32 bit), <b>unsigned8</b> , <b>unsigned16</b> , <b>unsigned32</b> , <b>visible_string</b> (ASCII string without termination)
<i>Access</i>	Read-only ( <b>ro</b> ), write-only ( <b>wo</b> ) or read-write ( <b>rw</b> ); could be limited to read-only depending on the state of the drive, see the <b>Write override</b> attribute below.
<i>Write override</i>	Some objects cannot be written when the NMT state machine is in operational state ( <b>operational</b> , see §2.9) and/or the output power is enabled ( <b>power enabled</b> , see §3.2).
<i>Unit</i>	Measure unit of the object or if affected by the factor group (position, velocity and acceleration, see §3.7)
<i>Default value</i>	The value the object has with the factory settings
<i>PDO mappable</i>	Specify if the object could be mapped in a PDO
<i>NV storage</i>	If yes the object will be permanently stored in non-volatile memory when the user issues the command on object 1010h

### 5.1. Communication objects

Those are all implemented objects from the application layer and communication profile CiA DS301 V4.02; for further information on those objects refer to / 1.

#### 5.1.1. 1000h.0h: Device Type

<i>Object:</i>	<b>1000h.0h</b>	<b>Device Type</b>	
<i>Object Code:</i>	var	<i>Data Type:</i>	unsigned32
<i>Access:</i>	ro	<i>Write override:</i>	n/a
<i>Unit:</i>	n/a	<i>Default value:</i>	0002 0192h
<i>PDO mappable:</i>	no	<i>NV storage:</i>	n/a

Describes the type of device and its functionality. It is composed of a 16-bit (LSB) field, which describes the device profile that is used, and a second 16-bit (MSB) field, which gives additional information about optional functionality of the device. In this case the device profile is 402 (0192h) and the additional information indicate that is a servo drive (0002h).



**Figure 13: Structure of Device Type**

#### 5.1.2. 1001h.0h: Error register

<i>Object:</i>	<b>1001h.0h</b>	<b>Error register</b>	
<i>Object Code:</i>	var	<i>Data Type:</i>	unsigned8
<i>Access:</i>	ro	<i>Write override:</i>	n/a
<i>Unit:</i>	n/a	<i>Default value:</i>	n/a
<i>PDO mappable:</i>	yes	<i>NV storage:</i>	n/a

This object is an error register for the drive. It is a part of the EMCY object (§2.8).

### 5.1.3. 1002h.0h: Manufacturer Status Register

<b>Object:</b>	<b>1002h.0h</b>	<b>Manufacturer Status Register</b>	
<b>Object Code:</b>	var	<b>Data Type:</b>	unsigned32
<b>Access:</b>	ro	<b>Write override:</b>	n/a
<b>Unit:</b>	n/a	<b>Default value:</b>	n/a
<b>PDO mappable:</b>	yes	<b>NV storage:</b>	n/a

This is the common status register specific for the manufacturer. It is a part of the EMCY object (§2.8).

### 5.1.4. 1005h.0h: COB-ID Sync Message

<b>Object:</b>	<b>1005h.0h</b>	<b>COB-ID Sync Message</b>	
<b>Object Code:</b>	var	<b>Data Type:</b>	unsigned32
<b>Access:</b>	rw	<b>Write override:</b>	operational
<b>Unit:</b>	n/a	<b>Default value:</b>	0000 0080h
<b>PDO mappable:</b>	no	<b>NV storage:</b>	yes

Defines the COB-ID of the Synchronization Object (§2.7). Bits 0-10 define the COB-ID, bits 11-31 should be leaved 0.



Figure 14: Structure of COB-ID Sync Message

### 5.1.5. 1008h.0h: Manufacturer Device Name

<b>Object:</b>	<b>1008h.0h</b>	<b>Manufacturer Device Name</b>	
<b>Object Code:</b>	var	<b>Data Type:</b>	visible_string
<b>Access:</b>	ro	<b>Write override:</b>	n/a
<b>Unit:</b>	n/a	<b>Default value:</b>	n/a
<b>PDO mappable:</b>	no	<b>NV storage:</b>	n/a

Contain the device code of the Twx Motor.

### 5.1.6. 100Ah.0h: Manufacturer Software Version

<b>Object:</b>	<b>100Ah.0h</b>	<b>Manufacturer Software Version</b>	
<b>Object Code:</b>	var	<b>Data Type:</b>	visible_string
<b>Access:</b>	ro	<b>Write override:</b>	n/a
<b>Unit:</b>	n/a	<b>Default value:</b>	n/a
<b>PDO mappable:</b>	no	<b>NV storage:</b>	n/a

Contain the software release number and the release date.

### 5.1.7. 100Ch.0h: Guard Time

<b>Object:</b>	<b>100Ch.0h</b>	<b>Guard Time</b>	
<b>Object Code:</b>	var	<b>Data Type:</b>	unsigned16
<b>Access:</b>	rw	<b>Write override:</b>	operational
<b>Unit:</b>	ms	<b>Default value:</b>	0
<b>PDO mappable:</b>	no	<b>NV storage:</b>	yes

The objects at index 100Ch and 100Dh include the guard time in milliseconds and the life time factor. The life time factor multiplied with the guard time gives the life time for the Node Guarding Protocol (§2.9). If 0 then it is disabled.

### 5.1.8. 100Dh.0h: Life Time Factor

<b>Object:</b>	<b>100Dh.0h</b>	<b>Life Time Factor</b>	
<b>Object Code:</b>	var	<b>Data Type:</b>	unsigned8
<b>Access:</b>	rw	<b>Write override:</b>	operational
<b>Unit:</b>	n/a	<b>Default value:</b>	0
<b>PDO mappable:</b>	no	<b>NV storage:</b>	yes

The life time factor multiplied with the guard time gives the life time for the Node Guarding Protocol (§2.9). If 0 then it is disabled.

### 5.1.9. 1010h: Store Parameters

<b>Object:</b>	<b>1010h</b>	<b>Store Parameters</b>	
<b>Object Code:</b>	array	<b>Data Type:</b>	unsigned32

This object let the drive to save all parameters in non-volatile memory. By read access the device provides information about its saving capabilities.

<b>Sub-index:</b>	<b>0h</b>	<b>Large sub-index supported</b>	
<b>Data type:</b>	unsigned8		
<b>Access:</b>	ro	<b>Write override:</b>	n/a
<b>Unit:</b>	n/a	<b>Default value:</b>	no
<b>PDO mappable:</b>	no	<b>NV storage:</b>	no

The large sub-index supported for this object, in this case 1.

<b>Sub-index:</b>	<b>1h</b>	<b>Store all</b>	
<b>Data type:</b>	unsigned32		
<b>Access:</b>	rw	<b>Write override:</b>	operational, power enabled
<b>Unit:</b>	n/a	<b>Default value:</b>	no
<b>PDO mappable:</b>	no	<b>NV storage:</b>	no

This command let the drive store all parameters that have the attribute NV storage. In order to avoid storage of parameters by mistake, storage is only executed when a specific signature is written to the appropriate sub-Index. The signature is the string **save** (or the 32 bit number 6576 6173h). On read the drive provides information about its storage functionality, in this case storage is executed only on command, not autonomously. It is possible to store a configuration version in the object 5312h.0h.

### 5.1.10. 1011h: Restore Default Parameters

<b>Object:</b>	<b>1011h</b>	<b>Restore Default Parameters</b>	
<b>Object Code:</b>	array	<b>Data Type:</b>	unsigned32

With this object the default values of parameters according to the communication or device profile are restored.

<b>Sub-index:</b>	<b>0h</b>	<b>Large sub-index supported</b>	
<b>Data type:</b>	unsigned8		
<b>Access:</b>	ro	<b>Write override:</b>	n/a
<b>Unit:</b>	n/a	<b>Default value:</b>	no
<b>PDO mappable:</b>	no	<b>NV storage:</b>	no

The large sub-index supported for this object, in this case 1.

<b>Sub-index:</b>	<b>1h</b>	<b>Restore all defaults</b>	
<b>Data type:</b>	unsigned32		
<b>Access:</b>	rw	<b>Write override:</b>	operational, power enabled
<b>Unit:</b>	n/a	<b>Default value:</b>	no
<b>PDO mappable:</b>	no	<b>NV storage:</b>	no

This command let the drive restore all parameters to the factory settings. In order to avoid restore of parameters by mistake, restore is only executed when a specific signature is written to the appropriate sub-Index. The signature is the string **load** (or the 32 bit number 6461 6F6Ch). This command have to be completed by issuing a **reset** command (§2.9).

### 5.1.11. 1014h.0h: COB-ID Emergency Object

<b>Object:</b>	<b>1014h.0h</b>	<b>COB-ID Emergency Object</b>	
<b>Object Code:</b>	var	<b>Data Type:</b>	unsigned32
<b>Access:</b>	rw	<b>Write override:</b>	operational
<b>Unit:</b>	n/a	<b>Default value:</b>	0000 0080h + node-ID
<b>PDO mappable:</b>	no	<b>NV storage:</b>	yes

Defines the COB-ID of the EMCY (§2.8). Bits 0-10 define the COB-ID, bit 31 defines if the EMCY is enabled (equal to 0) or if it is disabled (equal to 1); bits 11-30 should be leaved 0.

MSB	LSB
E	Unused (20 bit), should be 0
	COB-ID (11 bit)

Figure 15: Structure of COB-ID Emergency Message

#### 5.1.12. 1015h.0h: Inhibit Time of Emergency Object

<b>Object:</b>	<b>1015h.0h</b>	<b>Inhibit Time of Emergency Object</b>	
<b>Object Code:</b>	var	<b>Data Type:</b>	unsigned16
<b>Access:</b>	rw	<b>Write override:</b>	operational
<b>Unit:</b>	100 μs	<b>Default value:</b>	0
<b>PDO mappable:</b>	no	<b>NV storage:</b>	yes

The inhibit time for the EMCY (§2.8) can be adjusted via this entry. To guarantee that no starvation on the network occurs for data objects with low priorities, data objects can be assigned an inhibit time; this defines the minimum time that has to elapse between two consecutive invocations of a transmission service for that data object.

#### 5.1.13. 1017h.0h: Producer Heartbeat Time

<b>Object:</b>	<b>1017h.0h</b>	<b>Producer Heartbeat Time</b>	
<b>Object Code:</b>	var	<b>Data Type:</b>	unsigned16
<b>Access:</b>	rw	<b>Write override:</b>	operational
<b>Unit:</b>	ms	<b>Default value:</b>	0
<b>PDO mappable:</b>	no	<b>NV storage:</b>	yes

The producer heartbeat time defines the cycle time of the heartbeat for the Node Guarding Protocol (§2.9). If 0 then it is disabled.

#### 5.1.14. 1018h: Identity Object

<b>Object:</b>	<b>1018h</b>	<b>Identity Object</b>	
<b>Object Code:</b>	array	<b>Data Type:</b>	unsigned32

The object at index 1018h contains general information about the device.

<b>Sub-index:</b>	<b>0h</b>	<b>Number of entries</b>	
<b>Data type:</b>	unsigned8		
<b>Access:</b>	ro	<b>Write override:</b>	n/a
<b>Unit:</b>	n/a	<b>Default value:</b>	4
<b>PDO mappable:</b>	no	<b>NV storage:</b>	no

<b>Sub-index:</b>	<b>1h</b>	<b>Vendor ID</b>	
<b>Data type:</b>	unsigned32		
<b>Access:</b>	ro	<b>Write override:</b>	n/a
<b>Unit:</b>	n/a	<b>Default value:</b>	no
<b>PDO mappable:</b>	no	<b>NV storage:</b>	no

This is a unique value assigned to each manufacturer by CiA, in this case for Phase Motion Control is 0000 00D9h.

<b>Sub-index:</b>	<b>2h</b>	<b>Product Code</b>	
<b>Data type:</b>	unsigned32		
<b>Access:</b>	ro	<b>Write override:</b>	n/a
<b>Unit:</b>	n/a	<b>Default value:</b>	no
<b>PDO mappable:</b>	no	<b>NV storage:</b>	no

This is the product code of the device.

<b>Sub-index:</b>	<b>3h</b>	<b>Revision Number</b>	
<b>Data type:</b>	unsigned32		
<b>Access:</b>	ro	<b>Write override:</b>	n/a
<b>Unit:</b>	n/a	<b>Default value:</b>	no
<b>PDO mappable:</b>	no	<b>NV storage:</b>	no

This is the firmware release number, with the subfields structured as follow:

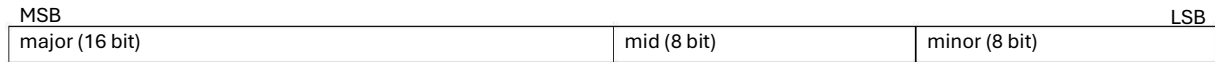

**Figure 16: Structure of Revision Number**

<i>Sub-index:</i>	<b>4h</b>	<b>Serial number</b>	
<i>Data type:</i>	unsigned32		
<i>Access:</i>	ro	<i>Write override:</i>	n/a
<i>Unit:</i>	n/a	<i>Default value:</i>	no
<i>PDO mappable:</i>	no	<i>NV storage:</i>	no

This is the serial number of the Twx Motor, the same appears on the side of the case.

### 5.1.15. 1400h: Receive PDO Communication Parameter

<i>Object:</i>	<b>1400h</b>	<b>Receive PDO Communication Parameter</b>	
<i>Object Code:</i>	record	<i>Data Type:</i>	n/a

The purpose of this data structure is to define the communication parameters for all RPDO; for each RPDO exist one object, the object index range from 1400h (RPDO #1) to 1407h (RPDO #8).

Prior to any modification of the following parameters, the desired PDO have to be disabled, by setting to 1 the bit 31 of the COB-ID.

<i>Sub-index:</i>	<b>0h</b>	<b>Number of entries</b>	
<i>Data type:</i>	unsigned8		
<i>Access:</i>	ro	<i>Write override:</i>	n/a
<i>Unit:</i>	n/a	<i>Default value:</i>	2
<i>PDO mappable:</i>	no	<i>NV storage:</i>	no

<i>Sub-index:</i>	<b>1h</b>	<b>COB-ID of the PDO</b>	
<i>Data type:</i>	unsigned32		
<i>Access:</i>	rw	<i>Write override:</i>	operational
<i>Unit:</i>	n/a	<i>Default value:</i>	yes (see Appendix B)
<i>PDO mappable:</i>	no	<i>NV storage:</i>	yes

Define the COB-ID and the state (enabled/disabled) of the RPDO. Bits 0-10 define the COB-ID, bit 31 defines if the PDO is enabled (equal to 0) or if it is disabled (equal to 1); bit 30 should be leaved 1, while bits 11-29 should be leaved 0. COB-ID have to be defined between 181h and 57Fh.



**Figure 17: Structure of RPDO's COB-ID**

<i>Sub-index:</i>	<b>2h</b>	<b>Transmission type</b>	
<i>Data type:</i>	unsigned8		
<i>Access:</i>	rw	<i>Write override:</i>	operational
<i>Unit:</i>	n/a	<i>Default value:</i>	yes (see Appendix B)
<i>PDO mappable:</i>	no	<i>NV storage:</i>	yes

This field defines the transmission type of RPDO and then when received data should be used.

<i>Transmission type</i>	<i>cyclic</i>	<i>acyclic</i>	<i>synchronous</i>	<i>asynchronous</i>
0		X	X	
1-240	X		X	
255				X

For further information on RPDOs refer to §2.6, to the below chapter for mapping and to §6.2 for examples.

### 5.1.16. 1600h: Receive PDO Mapping Parameter

<i>Object:</i>	<b>1600h</b>	<b>Receive PDO Mapping Parameter</b>	
<i>Object Code:</i>	array	<i>Data Type:</i>	unsigned32

The purpose of this data structure is to define the data mapping for all RPDO; for each RPDO exist one object, the object index range from 1600h (RPDO #1) to 1607h (RPDO #8).

Prior to any modification of the following parameters, the desired PDO have to be disabled, by setting to 1 the bit 31 of the COB-ID.

<i>Sub-index:</i>	<b>0h</b>	<b>Number of object mapped</b>	
<i>Data type:</i>	unsigned8		
<i>Access:</i>	rw	<i>Write override:</i>	operational
<i>Unit:</i>	n/a	<i>Default value:</i>	yes (see Appendix B)
<i>PDO mappable:</i>	no	<i>NV storage:</i>	yes

This parameter determines the valid number of objects that have been mapped. For changing the PDO mapping first the PDO has to be deleted, this parameter has to be set to 0 (mapping is deactivated). Then the objects can be remapped. After all objects are mapped this parameter is to be written with the valid number of mapped objects.

<i>Sub-index:</i>	<b>1h-8h</b>	<b>PDO Mapping</b>	
<i>Data type:</i>	unsigned32		
<i>Access:</i>	rw	<i>Write override:</i>	operational
<i>Unit:</i>	n/a	<i>Default value:</i>	yes (see Appendix B)
<i>PDO mappable:</i>	no	<i>NV storage:</i>	yes

These entries describe the PDO contents by their index, sub-index and length. The length entry contains the length of the object in bit (8, 16, 32) and has to match the object length. This parameter is used to verify the overall mapping length.

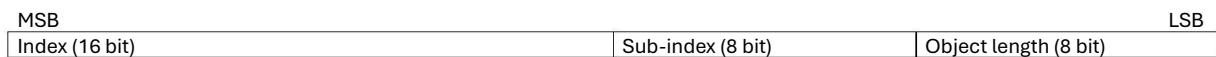

**Figure 18: Structure of PDO Mapping Entry**

When a new object is mapped by writing a sub-index between 1 and 8, the drive checks whether the object specified by index / sub-index exists. If the object does not exist or the object cannot be mapped, an abort SDO is issued.

If data types (index 0002h-0007h) are mapped they serve as **dummy entries**. The corresponding data in the PDO is not evaluated by the device. This optional feature is useful e.g. to transmit data to several devices using one PDO, each device only using its own part of the PDO. E.g., if the first 16 bit of a RPDO is to be discarded, map the value 0003 0010h or 0006 0010h (refer to [Figure 18](#)) on the first object (sub-index 1).

<i>Index</i>	<i>Object type</i>
0002h	INTEGER8
0003h	INTEGER16
0004h	INTEGER32
0005h	UNSIGNED8
0006h	UNSIGNED16
0007h	UNSIGNED32

For further information on RPDOs refer to §2.6 and to §6.2 for examples.

### 5.1.17. 1800h: Transmit PDO Communication Parameter

<i>Object:</i>	<b>1800h</b>	<b>Transmit PDO Communication Parameter</b>	
<i>Object Code:</i>	record	<i>Data Type:</i>	n/a

The purpose of this data structure is to define the communication parameters for all TPDO; for each TPDO exist one object, the object index range from 1800h (TPDO #1) to 1807h (TPDO #8).

Prior to any modification of the following parameters, the desired PDO have to be disabled, by setting to 1 the bit 31 of the COB-ID.

<i>Sub-index:</i>	<b>0h</b>	<b>Number of entries</b>	
<i>Data type:</i>	unsigned8		
<i>Access:</i>	ro	<i>Write override:</i>	n/a
<i>Unit:</i>	n/a	<i>Default value:</i>	3
<i>PDO mappable:</i>	no	<i>NV storage:</i>	no

<i>Sub-index:</i>	<b>1h</b>	<b>COB-ID of the PDO</b>	
<i>Data type:</i>	unsigned32		
<i>Access:</i>	rw	<i>Write override:</i>	operational
<i>Unit:</i>	n/a	<i>Default value:</i>	yes (see Appendix B)
<i>PDO mappable:</i>	no	<i>NV storage:</i>	yes

Define the COB-ID and the state (enabled/disabled) of the TPDO. Bits 0-10 define the COB-ID, bit 31 defines if the PDO is enabled (equal to 0) or if it is disabled (equal to 1); bit 30 defines if RTR is allowed (equal to 0) or not (equal to 1) on this PDO; bits 11-29 should be leaved 0. COB-ID have to be defined between 181h and 57Fh.

MSB			LSB		
E	R	Unused (19 bit), should be 0	COB-ID (11 bit)		

**Figure 19: Structure of TPDO's COB-ID**

<i>Sub-index:</i>	<b>2h</b>	<b>Transmission type</b>	
<i>Data type:</i>	unsigned8		
<i>Access:</i>	rw	<i>Write override:</i>	operational
<i>Unit:</i>	n/a	<i>Default value:</i>	yes (see Appendix B)
<i>PDO mappable:</i>	no	<i>NV storage:</i>	yes

This field defines the transmission type of TPDO and then when the data should be transmitted.

<i>Transmission type</i>	<i>cyclic</i>	<i>acyclic</i>	<i>synchronous</i>	<i>asynchronous</i>	<i>RTR only</i>
0		X	X		
1-240	X		X		
252			X		X
253				X	X
254				X	
255				X	

<i>Sub-index:</i>	<b>3h</b>	<b>Inhibit time</b>	
<i>Data type:</i>	unsigned16		
<i>Access:</i>	rw	<i>Write override:</i>	operational
<i>Unit:</i>	100 μs	<i>Default value:</i>	yes (see Appendix B)
<i>PDO mappable:</i>	no	<i>NV storage:</i>	yes

This defines the minimum time that has to elapse between two consecutive invocations of a transmission service for the TPDO; it is possible to set this object only for asynchronous TPDO.

For further information on TPDOs refer to §2.6, to the below chapter for mapping and to §6.2 for examples.

#### 5.1.18. 1A00h: Transmit PDO Mapping Parameter

<i>Object:</i>	<b>1A00h</b>	<b>Transmit PDO Mapping Parameter</b>	
<i>Object Code:</i>	array	<i>Data Type:</i>	unsigned32

The purpose of this data structure is to define the data mapping for all TPDO; for each TPDO exist one object, the object index range from 1A00h (TPDO #1) to 1A07h (TPDO #8).

Prior to any modification of the following parameters, the desired PDO have to be disabled, by setting to 1 the bit 31 of the COB-ID.

<i>Sub-index:</i>	<b>0h</b>	<b>Number of object mapped</b>	
<i>Data type:</i>	unsigned8		
<i>Access:</i>	rw	<i>Write override:</i>	operational
<i>Unit:</i>	n/a	<i>Default value:</i>	yes (see Appendix B)
<i>PDO mappable:</i>	no	<i>NV storage:</i>	yes

This parameter determines the valid number of objects that have been mapped. For changing the PDO mapping first the PDO has to be deleted, this parameter has to be set to 0 (mapping is deactivated). Then the objects can be remapped. After all objects are mapped this parameter is to be written with the valid number of mapped objects.

<i>Sub-index:</i>	<b>1h-8h</b>	<b>PDO Mapping</b>	
<i>Data type:</i>	unsigned32		
<i>Access:</i>	rw	<i>Write override:</i>	operational
<i>Unit:</i>	n/a	<i>Default value:</i>	yes (see Appendix B)
<i>PDO mappable:</i>	no	<i>NV storage:</i>	yes

These entries describe the PDO contents by their index, sub-index and length. The length entry contains the length of the object in bit (8, 16, 32) and have to match the object length (see Figure 18). This parameter is used to verify the overall mapping length. When a new object is mapped by writing a sub-index between 1 and 8, the drive checks whether the object specified by index / sub-index exists. If the object does not exist or the object cannot be mapped, an abort SDO is issued.

For further information on TPDOs refer to §2.6 and to §6.2 for examples.

## 5.2. Profile specific objects

Those are all implemented objects from the device profile drives and motion control CiA DSP402 V2.0; for further information on those objects refer to / 3.

### 5.2.1. 6007h.0h: Abort connection option code

<i>Object:</i>	<b>6007h.0h</b>	<b>Abort connection option code</b>	
<i>Object Code:</i>	var	<i>Data Type:</i>	integer16
<i>Access:</i>	rw	<i>Write override:</i>	operational, power enabled
<i>Unit:</i>	n/a	<i>Default value:</i>	0
<i>PDO mappable:</i>	no	<i>NV storage:</i>	yes

The content of this object selects the function to be performed when the connection to the network is lost: CAN bus-off, CAN in error passive mode, life guard error (if active), sync controller error or nmt state changed (except the PRE-OPERATIONAL to OPERATIONAL transition). The action could be one of the following:

<i>Option code</i>	<i>Description</i>
0	No action
2	Issue a device control command <b>Disable Voltage</b>
3	Issue a device control command <b>Quick Stop</b>

For further information look at §2.8 and §3.2.

### 5.2.2. 603Fh.0h: Error code

<i>Object:</i>	<b>603Fh.0h</b>	<b>Error code</b>	
<i>Object Code:</i>	var	<i>Data Type:</i>	unsigned16
<i>Access:</i>	ro	<i>Write override:</i>	n/a
<i>Unit:</i>	n/a	<i>Default value:</i>	0
<i>PDO mappable:</i>	yes	<i>NV storage:</i>	n/a

The Error code captures the code of the last error that occurred in the drive. It corresponds to the value of the first 16 bits of the EMCY object (§2.8).

### 5.2.3. 6502h.0h: Supported drive modes

<i>Object:</i>	<b>6502h.0h</b>	<b>Supported drive modes</b>	
<i>Object Code:</i>	var	<i>Data Type:</i>	unsigned32
<i>Access:</i>	ro	<i>Write override:</i>	n/a
<i>Unit:</i>	n/a	<i>Default value:</i>	n/a
<i>PDO mappable:</i>	yes	<i>NV storage:</i>	n/a

A drive can support more than one and several distinct modes of operation. This object gives an overview of the implemented operating modes in the device. In the Twx Motor this is equal to 03E5h



5.2.4. 6504h.0h: Manufacturer Name

<b>Object:</b>	<b>6504h.0h</b>	<b>Manufacturer Name</b>		
<b>Object Code:</b>	var		<b>Data Type:</b>	visible_string
<b>Access:</b>	ro		<b>Write override:</b>	n/a
<b>Unit:</b>	n/a		<b>Default value:</b>	n/a
<b>PDO mappable:</b>	no		<b>NV storage:</b>	n/a

The manufacturer name.

5.2.5. 6040h.0h: Controlword

<b>Object:</b>	<b>6040h.0h</b>	<b>Controlword</b>		
<b>Object Code:</b>	var		<b>Data Type:</b>	unsigned16
<b>Access:</b>	rw		<b>Write override:</b>	n/a
<b>Unit:</b>	n/a		<b>Default value:</b>	no
<b>PDO mappable:</b>	yes		<b>NV storage:</b>	no

The controlword contains the bits for controlling the state machine (§3.2) and for controlling the specific operating mode.

MSB							LSB			
reserved (7 bit)	halt	fault reset	O3	O2	O1	enable oper.	quick stop	enable volt.	switch on	

**Figure 20: Structure of controlword**

The O1, O2, O3 are operating mode specific bits:

Bit	Position profile	Velocity profile	Interpolated profile	Torque mode	Homing mode	Rotary table
O1	new set-point	reserved	reserved	reserved	homing operation start	new set-point
O2	change set immediately	reserved	reserved	reserved	reserved	absolute without best-route
O3	abs/rel	reserved	reserved	reserved	reserved	relative

**Table 33: Controlword operating mode specific bits**

The reserved bit are for future enhancements, should be kept to 0.

5.2.6. 6041h.0h: Statusword

<b>Object:</b>	<b>6041h.0h</b>	<b>Statusword</b>		
<b>Object Code:</b>	var		<b>Data Type:</b>	unsigned16
<b>Access:</b>	ro		<b>Write override:</b>	n/a
<b>Unit:</b>	n/a		<b>Default value:</b>	no
<b>PDO mappable:</b>	yes		<b>NV storage:</b>	no

The statusword indicates the current state of the drive (§3.2) and the current state of the specific operating mode.

Bit	Name	Description
0	Ready to switch on	see Device Control (§3.2)
1	Switched on	see Device Control (§3.2)
2	Operation enabled	see Device Control (§3.2)
3	Fault	see Device Control (§3.2)
4	Voltage enabled	Power output is enabled to the drive when this bit is set to 1
5	Quick stop	see Device Control (§3.2)
6	Switch on disabled	see Device Control (§3.2)
7	Warning	Used only in Rotary table control, issued if some incorrect parameter, refer to §4.4
8	reserved	
9	Remote	If set, then parameters may be modified via the CAN bus, and the drive executes the content of a command message. If the bit remote is reset, then the drive is in local mode and will not execute the command message.
10	Target reached	If set, then a set-point has been reached (not used in Torque Mode and Homing Mode). The set-point is dependent on the operating mode. The change of a target value by software alters this bit. If quick stop option code is 5 or 6 this bit is set when the quick stop operation is finished and the drive is halted. If halt occurred and the drive has halted then this bit is set too.

11	Internal limit active	It signal that the target position (if in Profile Position Mode) or the set-point (if in Interpolated Mode) was wrapped between minimum and maximum Software position limit (object 607Dh), due to exceeding value. It is reset with a new target position or set-point between the limits (not used in Torque Mode).
12	O1	
13	O2	
14	Rotary axis enabled	The rotary axis mode is enabled and the position objects are valid, refer to §4.1
15	Homing done	The homing is done, this bit remain active up to a node reset or a power-off, refer to §3.6

**Table 34: Structure of the statusword**

The O1 and O2 are operating mode specific bits:

Bit	Position profile	Velocity profile	Interpolated profile	Torque mode	Homing mode	Rotary table
O1	Set point acknowledge	Zero speed	lp mode active	reserved	Homing attained	Set point acknowledge
O2	Following error	Max slippage error	reserved	reserved	Homing error	reserved

**Table 35: Statusword operating mode specific bits**

The reserved bit is for future enhancements, it has to be ignored.

### 5.2.7. 605Bh.0h: Shutdown option code

<b>Object:</b>	<b>605Bh.0h</b>	<b>Shutdown option code</b>	
<b>Object Code:</b>	var	<b>Data Type:</b>	integer16
<b>Access:</b>	rw	<b>Write override:</b>	operational,power enabled
<b>Unit:</b>	n/a	<b>Default value:</b>	0
<b>PDO mappable:</b>	no	<b>NV storage:</b>	yes

This parameter determines what action should be taken if there is a transition from **Operation enable** to **Ready to switch on** (transition 8). The action could be one of the following:

Option code	Description
0	Disable drive function
1	Slow down with slow down ramp; disable of the drive function

For further information look at §3.2.

### 5.2.8. 605Ch.0h: Disable operation option code

<b>Object:</b>	<b>605Ch.0h</b>	<b>Disable operation option code</b>	
<b>Object Code:</b>	var	<b>Data Type:</b>	integer16
<b>Access:</b>	rw	<b>Write override:</b>	operational,power enabled
<b>Unit:</b>	n/a	<b>Default value:</b>	1
<b>PDO mappable:</b>	no	<b>NV storage:</b>	yes

This parameter determines what action should be taken if there is a transition from **Operation enable** to **Switched on** (transition 5). The action could be one of the following:

Option code	Description
0	Disable drive function
1	Slow down with slow down ramp; disable of the drive function

For further information look at §3.2.

### 5.2.9. 605Ah.0h: Quick stop option code

<b>Object:</b>	<b>605Ah.0h</b>	<b>Quick stop option code</b>	
<b>Object Code:</b>	var	<b>Data Type:</b>	integer16
<b>Access:</b>	rw	<b>Write override:</b>	operational,power enabled
<b>Unit:</b>	n/a	<b>Default value:</b>	2
<b>PDO mappable:</b>	no	<b>NV storage:</b>	yes

This determines what action should be taken if the **Quick stop** function is executed (transition 11). The action could be one of the following:

Option code	Description
0	Disable drive function
1	Slow down with slow down ramp; disable of the drive function
2	Slow down with quick stop ramp; disable of the drive function
5	Slow down with slow down ramp and stay in quick stop
6	Slow down with quick stop ramp and stay in quick stop

For further information look at §3.2.

### 5.2.10. 605Dh.0h: Halt option code

Object:	605Dh.0h	Halt option code	Data Type:	integer16
Object Code:	var		Write override:	operational,power enabled
Access:	rw		Default value:	1
Unit:	n/a		NV storage:	yes
PDO mappable:	no			

This determines what action should be taken if the bit 8 (**halt**) in the controlword is active. The action could be one of the following:

Option code	Description
0	Disable drive, motor is free to rotate
1	Slow down with slow down ramp
2	Slow down with quick stop ramp

For further information look at §3.2.

### 5.2.11. 605Eh.0h: Fault reaction option code

Object:	605Eh.0h	Fault reaction option code	Data Type:	integer16
Object Code:	var		Write override:	operational,power enabled
Access:	rw		Default value:	2
Unit:	n/a		NV storage:	yes
PDO mappable:	no			

The parameter fault reaction option code determines what action should be taken if a non-fault occurs in the drive. The action could be one of the following:

Option code	Description
0	Disable drive, motor is free to rotate
1	Slow down with slow down ramp
2	Slow down with quick stop ramp

For further information look at §3.2.

Object:	6060h.0h	Modes of operation	Data Type:	integer8
Object Code:	var		Write override:	no
Access:	rw		Default value:	1
Unit:	n/a		NV storage:	yes
PDO mappable:	yes			

### 5.2.12. 6060h.0h: Modes of operation

TWX servo eMotor are compliant to CiA DSP 402 and IEC 61800-7-201 standardized motion profiles

The 6060h parameter switches the actual operation mode of the TWX servo drive

TWX supported values are:

- 1 Profile position
- 3 Profile velocity
- 6 Homing
- 7 Interpolated position
- 127 Rotary table
- 128 Torque
- 8 Cyclic Position
- 9 Cyclic Velocity
- 10 Cyclic Torque

A read of **modes of operation** shows only the value of the parameter. The present mode of the drive is reflected in the object **modes of operation display** (object 6061h.0h).

For further information look at §3.2.

### 5.2.13. 6061h.0h: Modes of operation display

<b>Object:</b>	<b>6061h.0h</b>	<b>Modes of operation display</b>	
<b>Object Code:</b>	var	<b>Data Type:</b>	integer8
<b>Access:</b>	ro	<b>Write override:</b>	n/a
<b>Unit:</b>	n/a	<b>Default value:</b>	1
<b>PDO mappable:</b>	yes	<b>NV storage:</b>	n/a

The modes of operation display shows the current mode of operation. The meaning of the returned value corresponds to that of the modes of operation option code (object 6060h.0h).

For further information look at §3.2.

### 5.2.24. 607Ah.0h: Target position

<b>Object:</b>	<b>607Ah.0h</b>	<b>Target position</b>	
<b>Object Code:</b>	var	<b>Data Type:</b>	integer32
<b>Access:</b>	rw	<b>Write override:</b>	no
<b>Unit:</b>	position <a href="#">Factor group</a>	<b>Default value:</b>	no
<b>PDO mappable:</b>	yes	<b>NV storage:</b>	no

The target position is the position that the drive should move to in position profile mode using the current settings of motion control parameters such as velocity, acceleration, deceleration, motion profile type etc.

At start-up the content is unforeseeable, then the first positioning should be only absolute.

For further information look at §3.3.

### 5.2.25. 607Dh: Software position limit

<b>Object:</b>	<b>607Dh</b>	<b>Software position limit</b>	
<b>Object Code:</b>	array	<b>Data Type:</b>	n/a

These parameters define the absolute position limits (in the position profile mode or interpolated position mode only) for the **position demand value**. Every new **target position** or **position set-point** is verified and trimmed to remain between those limits. It affects the **Internal limit active** bit in the Statusword (object 6041h).

<i>Sub-index:</i>	<b>0h</b>	<b>Number of entries</b>	
<i>Data type:</i>	unsigned8		
<i>Access:</i>	ro	<i>Write override:</i>	n/a
<i>Unit:</i>	n/a	<i>Default value:</i>	2
<i>PDO mappable:</i>	no	<i>NV storage:</i>	n/a

<i>Sub-index:</i>	<b>1h</b>	<b>Min position limit</b>	
<i>Data type:</i>	integer32		
<i>Access:</i>	rw	<i>Write override:</i>	no
<i>Unit:</i>	position <a href="#">Factor group</a>	<i>Default value:</i>	-2147483648
<i>PDO mappable:</i>	yes	<i>NV storage:</i>	yes

<i>Sub-index:</i>	<b>2h</b>	<b>Max position limit</b>	
<i>Data type:</i>	integer32		
<i>Access:</i>	rw	<i>Write override:</i>	no
<i>Unit:</i>	position <a href="#">Factor group</a>	<i>Default value:</i>	2147483647
<i>PDO mappable:</i>	yes	<i>NV storage:</i>	yes

For further information look at §3.3 and at §3.5.

### 5.2.26. 6081h.0h: Profile velocity

<i>Object:</i>	<b>6081h.0h</b>	<b>Profile velocity</b>	
<i>Object Code:</i>	var	<i>Data Type:</i>	unsigned32
<i>Access:</i>	rw	<i>Write override:</i>	no
<i>Unit:</i>	velocity <a href="#">Factor group</a>	<i>Default value:</i>	23068672 (~135 rad/s)
<i>PDO mappable:</i>	yes	<i>NV storage:</i>	yes

The profile velocity is the velocity normally attained at the end of the acceleration ramp during a profiled move and is valid for both directions of motion. For further information look at §3.3.

### 5.2.28. 6083h.0h: Profile acceleration

<i>Object:</i>	<b>6083h.0h</b>	<b>Profile acceleration</b>	
<i>Object Code:</i>	var	<i>Data Type:</i>	unsigned32
<i>Access:</i>	rw	<i>Write override:</i>	no
<i>Unit:</i>	acceleration <a href="#">Factor group</a>	<i>Default value:</i>	4096 (~95.9 rad/s <sup>2</sup> )
<i>PDO mappable:</i>	yes	<i>NV storage:</i>	yes

The profile acceleration is given in user defined acceleration units. For further information look at §3.3 and at §3.4.

### 5.2.29. 6084h.0h: Profile deceleration

<i>Object:</i>	<b>6084h.0h</b>	<b>Profile deceleration</b>	
<i>Object Code:</i>	var	<i>Data Type:</i>	unsigned32
<i>Access:</i>	rw	<i>Write override:</i>	no
<i>Unit:</i>	acceleration <a href="#">Factor group</a>	<i>Default value:</i>	4096 (~95.9 rad/s <sup>2</sup> )
<i>PDO mappable:</i>	yes	<i>NV storage:</i>	yes

The profile deceleration is given in user defined acceleration units. It is used also for the slow down ramp when selected as option code. For further information look at §3.2, §3.3 and at §3.4.

### 5.2.30. 6085h.0h: Quick stop deceleration

<b>Object:</b>	<b>6085h.0h</b>	<b>Quick stop deceleration</b>	
<b>Object Code:</b>	var	<b>Data Type:</b>	unsigned32
<b>Access:</b>	rw	<b>Write override:</b>	no
<b>Unit:</b>	acceleration <a href="#">Factor group</a>	<b>Default value:</b>	16384 (~383 rad/s <sup>2</sup> )
<b>PDO mappable:</b>	yes	<b>NV storage:</b>	yes

The quick stop deceleration is the deceleration used to stop the motor if the quick stop ramp is selected as option code. For further information look at §3.2.

### 5.2.31. 6086h.0h: Motion profile type

<b>Object:</b>	<b>6086h.0h</b>	<b>Motion profile type</b>	
<b>Object Code:</b>	var	<b>Data Type:</b>	Integer16
<b>Access:</b>	rw	<b>Write override:</b>	no
<b>Unit:</b>	n/a	<b>Default value:</b>	0
<b>PDO mappable:</b>	yes	<b>NV storage:</b>	yes

The motion profile type is used to select the type of motion profile used to perform a profiled move. The Twx Motor supports only the linear ramp (trapezoidal profile) that is the type 0. To smooth the edges of this kind of profile (like the jerk-limited profile), Twx Motor provide a 2<sup>nd</sup> order digital filter (refer to §4.7).

For further information look at §3.3.

### 5.2.32. 607Ch.0h: Home offset

<b>Object:</b>	<b>607Ch.0h</b>	<b>Home offset</b>	
<b>Object Code:</b>	var	<b>Data Type:</b>	integer32
<b>Access:</b>	rw	<b>Write override:</b>	no
<b>Unit:</b>	position <a href="#">Factor group</a>	<b>Default value:</b>	0
<b>PDO mappable:</b>	yes	<b>NV storage:</b>	yes

The home offset object is the difference between the zero position for the application and the machine home position (found during homing). This object affects the values read from the position encoder:

$$position\ actual\ value = encoder\ position + home\ offset$$

The object could be written also when the power output is enabled and the shaft is running, as the writing does not affect any internal system status variables.

For further information look at Appendix A and at §4.5.

### 5.2.33. 6098h.0h: Homing method

<b>Object:</b>	<b>6098h.0h</b>	<b>Homing method</b>	
<b>Object Code:</b>	var	<b>Data Type:</b>	integer8
<b>Access:</b>	rw	<b>Write override:</b>	no
<b>Unit:</b>	n/a	<b>Default value:</b>	26
<b>PDO mappable:</b>	yes	<b>NV storage:</b>	yes

This object determines the method that will be used during homing. The possible values are: 19,20,21,22,26 and 30.

For further information look at §3.6.

### 5.2.34. 6099h: Homing speeds

<b>Object:</b>	<b>6099h</b>	<b>Homing speeds</b>	
<b>Object Code:</b>	array	<b>Data Type:</b>	n/a

This parameter define the speed in velocity units at which the home switch is sought during homing mode.

<b>Sub-index:</b>	<b>0h</b>	<b>Number of entries</b>	
<b>Data type:</b>	unsigned8		
<b>Access:</b>	ro	<b>Write override:</b>	n/a
<b>Unit:</b>	n/a	<b>Default value:</b>	2
<b>PDO mappable:</b>	no	<b>NV storage:</b>	n/a

<b>Sub-index:</b>	<b>1h</b>	<b>Speed during search for home switch</b>	
<b>Data type:</b>	unsigned32		
<b>Access:</b>	rw	<b>Write override:</b>	no
<b>Unit:</b>	velocity <a href="#">Factor group</a>	<b>Default value:</b>	23068672 (~135 rad/s)
<b>PDO mappable:</b>	yes	<b>NV storage:</b>	yes

<b>Sub-index:</b>	<b>2h</b>	<b>Not used</b>	
<b>Data type:</b>	unsigned32		
<b>Access:</b>	rw	<b>Write override:</b>	no
<b>Unit:</b>	velocity <a href="#">Factor group</a>	<b>Default value:</b>	0
<b>PDO mappable:</b>	yes	<b>NV storage:</b>	yes

For further information look at §3.6.

#### 5.2.35. 609Ah.0h: Homing acceleration

<b>Object:</b>	<b>609Ah.0h</b>	<b>Homing acceleration</b>	
<b>Object Code:</b>	var	<b>Data Type:</b>	unsigned32
<b>Access:</b>	rw	<b>Write override:</b>	no
<b>Unit:</b>	acceleration <a href="#">Factor group</a>	<b>Default value:</b>	4096 (~95.9 rad/s <sup>2</sup> )
<b>PDO mappable:</b>	yes	<b>NV storage:</b>	yes

This parameter define the acceleration at which the home switch is sought during homing mode. The homing acceleration is given in user defined acceleration units. For further information look at §3.6.

#### 5.2.36. 6062h.0h: Position demand value

<b>Object:</b>	<b>6062h.0h</b>	<b>Position demand value</b>	
<b>Object Code:</b>	var	<b>Data Type:</b>	integer32
<b>Access:</b>	ro	<b>Write override:</b>	n/a
<b>Unit:</b>	position <a href="#">Factor group</a>	<b>Default value:</b>	no
<b>PDO mappable:</b>	yes	<b>NV storage:</b>	n/a

This object represents the present position demand value output from the trajectory generator. For further information look at Appendix A.

#### 5.2.37. 6064h.0h: Position actual value

<b>Object:</b>	<b>6064h.0h</b>	<b>Position actual value</b>	
<b>Object Code:</b>	var	<b>Data Type:</b>	integer32
<b>Access:</b>	ro	<b>Write override:</b>	n/a
<b>Unit:</b>	position <a href="#">Factor group</a>	<b>Default value:</b>	no
<b>PDO mappable:</b>	yes	<b>NV storage:</b>	n/a

This object represents the present value of the position measurement device, normalized with home offset and polarized with the direction object. For further information look at Appendix A.

#### 5.2.38. 6065h.0h: Following error window

<b>Object:</b>	<b>6065h.0h</b>	<b>Following error window</b>	
<b>Object Code:</b>	var	<b>Data Type:</b>	integer32
<b>Access:</b>	rw	<b>Write override:</b>	no
<b>Unit:</b>	position <a href="#">Factor group</a>	<b>Default value:</b>	12288 (~1.178 rad)
<b>PDO mappable:</b>	yes	<b>NV storage:</b>	yes

The following error window defines the maximum tolerance on the following error; if the following error actual value is greater than following error window, a following error occurs. A following error might occur when a drive is blocked, unreachable profile velocity occurs, or at wrong closed loop coefficients. For further information look at §3.3.

#### 5.2.39. 6066h.0h: Following error time out

<b>Object:</b>	<b>6066h.0h</b>	<b>Following error time out</b>	
<b>Object Code:</b>	var	<b>Data Type:</b>	unsigned16
<b>Access:</b>	rw	<b>Write override:</b>	no
<b>Unit:</b>	ms	<b>Default value:</b>	10
<b>PDO mappable:</b>	yes	<b>NV storage:</b>	yes

When a following error occurs longer than the defined value of the time-out, the corresponding bit 13 following error in the statusword will be set to one. For further information look at §3.3.

#### 5.2.40. 6067h.0h: Position window

<b>Object:</b>	<b>6067h.0h</b>	<b>Position window</b>	
<b>Object Code:</b>	var	<b>Data Type:</b>	integer32
<b>Access:</b>	rw	<b>Write override:</b>	no
<b>Unit:</b>	position <a href="#">Factor group</a>	<b>Default value:</b>	256 (~0.025 rad)
<b>PDO mappable:</b>	yes	<b>NV storage:</b>	yes

The position window defines a symmetrical range of accepted positions relatively to the target position:

$$(target\ position - position\ window; target\ position + position\ window)$$

If the present value of the position encoder is within the position window, this target position is regarded as reached. For further information look at §3.3.

#### 5.2.41. 6068h.0h: Position window time

<b>Object:</b>	<b>6068h.0h</b>	<b>Position window time</b>	
<b>Object Code:</b>	var	<b>Data Type:</b>	unsigned16
<b>Access:</b>	rw	<b>Write override:</b>	no
<b>Unit:</b>	ms	<b>Default value:</b>	20
<b>PDO mappable:</b>	yes	<b>NV storage:</b>	yes

When the present position is within the position window during the defined position window time, the corresponding bit 10 target reached in the statusword will be set to one. For further information look at §3.3.

#### 5.2.42. 60F4h.0h: Following error actual value

<b>Object:</b>	<b>60F4h.0h</b>	<b>Following error actual value</b>	
<b>Object Code:</b>	var	<b>Data Type:</b>	integer32
<b>Access:</b>	ro	<b>Write override:</b>	n/a
<b>Unit:</b>	position <a href="#">Factor group</a>	<b>Default value:</b>	no
<b>PDO mappable:</b>	yes	<b>NV storage:</b>	n/a

This object represents the present value of the following error.  
For further information look at Appendix A.

#### 5.2.43. 60C1h: Interpolation data record

<b>Object:</b>	<b>60C1h</b>	<b>Interpolation data record</b>	
<b>Object Code:</b>	array	<b>Data Type:</b>	integer32

The interpolation data record is the data words, which are necessary to perform the interpolation algorithm. For the linear interpolation mode each interpolation data record simply is regarded as a new position set-point. Those set-points could be optionally filtered by a user-defined 2<sup>nd</sup> order filter.

<b>Sub-index:</b>	<b>0h</b>	<b>Number of entries</b>	
<b>Data type:</b>	unsigned8		
<b>Access:</b>	ro	<b>Write override:</b>	n/a
<b>Unit:</b>	n/a	<b>Default value:</b>	1
<b>PDO mappable:</b>	no	<b>NV storage:</b>	n/a



<b>Sub-index:</b>	<b>1h</b>	<b>Position set-point</b>	
<b>Data type:</b>	integer32		
<b>Access:</b>	rw	<b>Write override:</b>	no
<b>Unit:</b>	position <a href="#">Factor group</a>	<b>Default value:</b>	no
<b>PDO mappable:</b>	yes	<b>NV storage:</b>	no

For further information look at §3.5 and to §4.7.

#### 5.2.44. 60C2h: Interpolation time period

<b>Object:</b>	<b>60C2h</b>	<b>Interpolation time period</b>	
<b>Object Code:</b>	record	<b>Data Type:</b>	n/a

The interpolation time period is used for time synchronized interpolation position modes, that is:

$$time\ period = time\ units \cdot 10^{interpolation\ time\ index}$$

The interpolation time period has to be multiple of 250µs.

<b>Sub-index:</b>	<b>0h</b>	<b>Number of entries</b>	
<b>Data type:</b>	unsigned8		
<b>Access:</b>	ro	<b>Write override:</b>	n/a
<b>Unit:</b>	n/a	<b>Default value:</b>	2
<b>PDO mappable:</b>	no	<b>NV storage:</b>	n/a

<b>Sub-index:</b>	<b>1h</b>	<b>Interpolation time units</b>	
<b>Data type:</b>	unsigned8		
<b>Access:</b>	rw	<b>Write override:</b>	no
<b>Unit:</b>	n/a	<b>Default value:</b>	1
<b>PDO mappable:</b>	no	<b>NV storage:</b>	yes

<b>Sub-index:</b>	<b>2h</b>	<b>Interpolation time index</b>	
<b>Data type:</b>	integer8		
<b>Access:</b>	rw	<b>Write override:</b>	no
<b>Unit:</b>	n/a	<b>Default value:</b>	-3
<b>PDO mappable:</b>	no	<b>NV storage:</b>	yes

For further information look at §3.5.

#### 5.2.45. 60C3h: Interpolation sync definition

<b>Object:</b>	<b>60C3h</b>	<b>Interpolation sync definition</b>	
<b>Object Code:</b>	array	<b>Data Type:</b>	unsigned8

Devices in the interpolation position mode often interact with other devices. Therefore it is necessary to define a communication object, which is used to synchronize these interactions. Synchronize on group could be only 0, this mean that SYNC is used.

<b>Sub-index:</b>	<b>0h</b>	<b>Number of entries</b>	
<b>Data type:</b>	unsigned8		
<b>Access:</b>	ro	<b>Write override:</b>	n/a
<b>Unit:</b>	n/a	<b>Default value:</b>	2
<b>PDO mappable:</b>	no	<b>NV storage:</b>	n/a

<b>Sub-index:</b>	<b>1h</b>	<b>Synchronize on group</b>	
<b>Data type:</b>	unsigned8		
<b>Access:</b>	rw	<b>Write override:</b>	no
<b>Unit:</b>	n/a	<b>Default value:</b>	0
<b>PDO mappable:</b>	no	<b>NV storage:</b>	yes

<i>Sub-index:</i>	<b>2h</b>	<b>ip sync every n event</b>	
<i>Data type:</i>	unsigned8		
<i>Access:</i>	rw	<i>Write override:</i>	no
<i>Unit:</i>	n/a	<i>Default value:</i>	1
<i>PDO mappable:</i>	no	<i>NV storage:</i>	yes

For further information look at §3.5.

#### 5.2.46. 6069h.0h: Velocity sensor actual value

<i>Object:</i>	<b>6069h.0h</b>	<b>Velocity sensor actual value</b>	
<i>Object Code:</i>	var	<i>Data Type:</i>	integer32
<i>Access:</i>	ro	<i>Write override:</i>	n/a
<i>Unit:</i>	velocity d.u., see <a href="#">Factor group</a>	<i>Default value:</i>	no
<i>PDO mappable:</i>	yes	<i>NV storage:</i>	n/a

The velocity sensor present value describes the velocity read from the encoder in d.u.

#### 5.2.47. 606Bh.0h: Velocity demand value

<i>Object:</i>	<b>606Bh.0h</b>	<b>Velocity demand value</b>	
<i>Object Code:</i>	var	<i>Data Type:</i>	integer32
<i>Access:</i>	ro	<i>Write override:</i>	n/a
<i>Unit:</i>	velocity <a href="#">Factor group</a>	<i>Default value:</i>	no
<i>PDO mappable:</i>	yes	<i>NV storage:</i>	n/a

This is the output value of the trajectory generator. For further information look at Appendix A.

#### 5.2.48. 606Ch.0h: Velocity actual value

<i>Object:</i>	<b>606Ch.0h</b>	<b>Velocity actual value</b>	
<i>Object Code:</i>	var	<i>Data Type:</i>	integer32
<i>Access:</i>	ro	<i>Write override:</i>	n/a
<i>Unit:</i>	velocity <a href="#">Factor group</a>	<i>Default value:</i>	no
<i>PDO mappable:</i>	yes	<i>NV storage:</i>	n/a

This object represents the present value of the velocity measurement device.  
For further information look at Appendix A.

#### 5.2.49. 606Dh.0h: Velocity window

<i>Object:</i>	<b>606Dh.0h</b>	<b>Velocity window</b>	
<i>Object Code:</i>	var	<i>Data Type:</i>	unsigned32
<i>Access:</i>	rw	<i>Write override:</i>	no
<i>Unit:</i>	velocity <a href="#">Factor group</a>	<i>Default value:</i>	1310720 (~7.67 rad/s)
<i>PDO mappable:</i>	yes	<i>NV storage:</i>	yes

The velocity window monitors whether the required process velocity has been achieved after an eventual acceleration or deceleration (braking) stage, looking for the actual velocity being between:

$$(target\ velocity - velocity\ window; target\ velocity + velocity\ window)$$

For further information look at §3.4.

#### 5.2.50. 606Eh.0h: Velocity window time

<i>Object:</i>	<b>606Eh.0h</b>	<b>Velocity window time</b>	
<i>Object Code:</i>	var	<i>Data Type:</i>	unsigned16
<i>Access:</i>	rw	<i>Write override:</i>	no
<i>Unit:</i>	ms	<i>Default value:</i>	30
<i>PDO mappable:</i>	yes	<i>NV storage:</i>	yes

The corresponding bit 10 target reached is set in the statusword when the difference between the target velocity and the velocity actual value is within the velocity window longer than the velocity window time. For further information look at §3.4.

5.2.51. 606Fh.0h: Velocity threshold

<b>Object:</b>	<b>606Fh.0h</b>	<b>Velocity threshold</b>	
<b>Object Code:</b>	var	<b>Data Type:</b>	integer32
<b>Access:</b>	rw	<b>Write override:</b>	no
<b>Unit:</b>	velocity <a href="#">Factor group</a>	<b>Default value:</b>	327680 (~1.92 rad/s)
<b>PDO mappable:</b>	yes	<b>NV storage:</b>	yes

As soon as the velocity actual value exceeds the velocity threshold longer than the velocity threshold time bit 12 is reset in the statusword. Below this threshold the bit is set and indicates that the axle is stationary. For further information look at §3.4.

5.2.52. 6070h.0h: Velocity threshold time

<b>Object:</b>	<b>6070h.0h</b>	<b>Velocity threshold time</b>	
<b>Object Code:</b>	var	<b>Data Type:</b>	unsigned16
<b>Access:</b>	rw	<b>Write override:</b>	no
<b>Unit:</b>	ms	<b>Default value:</b>	80
<b>PDO mappable:</b>	yes	<b>NV storage:</b>	yes

The velocity threshold time. For further information look at §3.4.

5.2.53. 60FFh.0h: Target velocity

<b>Object:</b>	<b>60FFh.0h</b>	<b>Target velocity</b>	
<b>Object Code:</b>	var	<b>Data Type:</b>	integer32
<b>Access:</b>	rw	<b>Write override:</b>	no
<b>Unit:</b>	velocity <a href="#">Factor group</a>	<b>Default value:</b>	no
<b>PDO mappable:</b>	yes	<b>NV storage:</b>	no

The target velocity is the input for the trajectory generator. For further information look at §3.4.

5.2.54. 60F9h: Velocity control parameter set

<b>Object:</b>	<b>60F9h</b>	<b>Velocity control parameter set</b>	
<b>Object Code:</b>	array	<b>Data Type:</b>	integer16

In order to control the behaviour of the speed control loop, one or more parameters are necessary. This object defines the parameter set for a speed loop of the Twx Motor. The p.u. for each parameter here is expressed assuming the **Output scaling magnitude** equal to 0 and then the final multiplication by 1.



**WARNING:** the values of this object could be written also during the normal drive working cycle, thus with power enabled and moving shaft. Be careful as modifying the values of this object with power enabled could yield in a loss of axle control.

<b>Sub-index:</b>	<b>0h</b>	<b>Number of entries</b>	
<b>Data type:</b>	unsigned8		
<b>Access:</b>	ro	<b>Write override:</b>	n/a
<b>Unit:</b>	n/a	<b>Default value:</b>	11
<b>PDO mappable:</b>	no	<b>NV storage:</b>	n/a

<b>Sub-index:</b>	<b>1h</b>	<b>Kp Speed reference</b>	
<b>Data type:</b>	integer16		
<b>Access:</b>	rw	<b>Write override:</b>	no
<b>Unit:</b>	$8.55 \cdot 10^6$ [Arms·s/rad]	<b>Default value:</b>	24576
<b>PDO mappable:</b>	yes	<b>NV storage:</b>	yes

<b>Sub-index:</b>	<b>2h</b>	<b>Kp Position</b>	
<b>Data type:</b>	integer16		
<b>Access:</b>	rw	<b>Write override:</b>	no
<b>Unit:</b>	$1.71 \cdot 10^4$ [Arms/rad]	<b>Default value:</b>	4096
<b>PDO mappable:</b>	yes	<b>NV storage:</b>	yes

Sub-index:	<b>3h</b>	<b>Ki</b>	
Data type:	integer16		
Access:	rw	Write override:	no
Unit:	8.19 [1/s]	Default value:	32
PDO mappable:	yes	NV storage:	yes

Sub-index:	<b>4h</b>	<b>Kp acceleration feedback</b>	
Data type:	integer16		
Access:	rw	Write override:	no
Unit:	$1.67 \cdot 10^7$ [Arms·s <sup>2</sup> /rad]	Default value:	0
PDO mappable:	yes	NV storage:	yes

Sub-index:	<b>5h</b>	<b>Kp acceleration reference</b>	
Data type:	integer16		
Access:	rw	Write override:	no
Unit:	$1.67 \cdot 10^7$ [Arms·s <sup>2</sup> /rad]	Default value:	0
PDO mappable:	yes	NV storage:	yes

Sub-index:	<b>6h</b>	<b>Output limiter</b>	
Data type:	integer16		
Access:	rw	Write override:	no
Unit:	current d.u., see <a href="#">Current loops</a>	Default value:	30720 (~5.64Arms)
PDO mappable:	yes	NV storage:	yes

Sub-index:	<b>7h</b>	<b>Reserved, do not use</b>	
Data type:	integer16		
Access:	rw	Write override:	no
Unit:	n/a	Default value:	n/a
PDO mappable:	yes	NV storage:	yes

Sub-index:	<b>8h</b>	<b>Reserved, do not use</b>	
Data type:	integer16		
Access:	rw	Write override:	No
Unit:	n/a	Default value:	n/a
PDO mappable:	yes	NV storage:	Yes

Sub-index:	<b>9h</b>	<b>Output scaling magnitude</b>	
Data type:	integer16		
Access:	rw	Write override:	No
Unit:	n/a	Default value:	yes (see <a href="#">Appendix C</a> )
PDO mappable:	yes	NV storage:	yes

Sub-index:	<b>Ah</b>	<b>Kp Speed feedback</b>	
Data type:	integer16		
Access:	rw	Write override:	no
Unit:	$8.55 \cdot 10^6$ [Arms·s/rad]	Default value:	24576
PDO mappable:	yes	NV storage:	yes

Sub-index:	<b>Bh</b>	<b>Position error limitation</b>	
Data type:	integer16		
Access:	rw	Write override:	No
Unit:	position d.u., see <a href="#">Factor group</a>	Default value:	16384 (~1.571 rad)
PDO mappable:	yes	NV storage:	Yes

For a complete schema blocks of the Twx Motor closed loop and the interaction between these parameters refer to [Appendix A](#) and to [§4.5](#); for further information about p.u. refer to [§3.7](#) and to [Appendix C](#).

### 5.2.55. 6079h.0h: DC link circuit voltage

Object:	<b>6079h.0h</b>	<b>DC link circuit voltage</b>	
Object Code:	var	Data Type:	unsigned32
Access:	ro	Write override:	n/a
Unit:	mV	Default value:	no
PDO mappable:	yes	NV storage:	n/a

This parameter describes the instantaneous DC link current voltage at the drive controller. For further information look at [§2.8](#) and the objects 5302h.0h and 5306h.0h.

This parameter could be used to store and retrieve any information the user needs for it's own application, for example to store the configuration version number to be checked at every power-up. For further information look at the objects 1010h and 1011h.

### 5.3.34. 5320h: Table positions array

<b>Object:</b>	<b>5320h</b>	<b>Table positions array</b>	
<b>Object Code:</b>	array	<b>Data Type:</b>	integer32

This array contain all the positions for the rotary table control, those are always expressed as d.u. Due to internal drive management, this array is stored in NV memory at same time as downloading.

Follow these points to download the array:

- first object to be downloaded is in the sub-index 1, this also prepare the NV storage
- download all the positions with incrementing sub-index
- the last valid position has to be followed by a position equal to -1, this close the NV storage and determines the number of entries (that could be read from sub-index 0)
- all following download (for every sub-index but 1) are ignored and do not return any error

<b>Sub-index:</b>	<b>0h</b>	<b>Number of entries</b>	
<b>Data type:</b>	unsigned8		
<b>Access:</b>	ro	<b>Write override:</b>	n/a
<b>Unit:</b>	n/a	<b>Default value:</b>	0
<b>PDO mappable:</b>	no	<b>NV storage:</b>	n/a

<b>Sub-index:</b>	<b>01h - 7Eh</b>	<b>Position setting</b>	
<b>Data type:</b>	integer32		
<b>Access:</b>	rw	<b>Write override:</b>	operational, power enabled
<b>Unit:</b>	position d.u., see <a href="#">Factor group</a>	<b>Default value:</b>	-1
<b>PDO mappable:</b>	no	<b>NV storage:</b>	done automatically during download

For further information look at §4.4.

### 5.3.35. 5321h.0h: Table dimension / Rotary axis dimension

<b>Object:</b>	<b>5321h.0h</b>	<b>Table dimension / Rotary axis dimension</b>	
<b>Object Code:</b>	var	<b>Data Type:</b>	unsigned32
<b>Access:</b>	rw	<b>Write override:</b>	no
<b>Unit:</b>	position d.u., see <a href="#">Factor group</a>	<b>Default value:</b>	no
<b>PDO mappable:</b>	yes	<b>NV storage:</b>	yes

This object contain the dimension of the generic rotary axis used to wrap the position objects; this is the same also for the rotary table control dimension. The wrapping keep position objects between 0 and <table dimension>-1.



**WARNING:** the values of this object could be written also during the normal drive working cycle, thus with power enabled and moving shaft. Wait until the **Rotary axis enabled** bit in the statusword (object 6041h.0h) is set before using position objects, as the drive could need some time to update his internal status.

For further information look at §4.4 and to §4.1.

### 5.3.36. 5322h.0h: Gear play compensation

<b>Object:</b>	<b>5322h.0h</b>	<b>Gear play compensation</b>	
<b>Object Code:</b>	var	<b>Data Type:</b>	unsigned32
<b>Access:</b>	rw	<b>Write override:</b>	no
<b>Unit:</b>	position d.u., see <a href="#">Factor group</a>	<b>Default value:</b>	no
<b>PDO mappable:</b>	yes	<b>NV storage:</b>	yes

This object define how much over-travel has to be done to compensate the gearbox play when the Rotary table control mode is enabled. The compensation is done only when the direction of rotation is counterclockwise by subtracting from the target position the gear play compensation value.

For further information look at §4.4.

5.3.37. 5323h.0h: Rotary table target index

<i>Object:</i>	<b>5323h.0h</b>	<b>Rotary table target index</b>	
<i>Object Code:</i>	var	<i>Data Type:</i>	integer16
<i>Access:</i>	rw	<i>Write override:</i>	no
<i>Unit:</i>	n/a	<i>Default value:</i>	no
<i>PDO mappable:</i>	yes	<i>NV storage:</i>	no

The target index for the Rotary table control. It have to be between 1 and the number of positions in the Table positions array (object 5320h), with positive or negative sign. It could be the absolute index on the rotary table that will be translated in a target position or a relative index that will be added to the current target index and wrapped to the number of positions of the Table positions array.

For further information look at §4.4.

5.3.38 5324h.0h: Table actual position

<i>Object</i>	5324h.0h		
<i>Object Code:</i>	var	<i>Data Type:</i>	integer32
<i>Access:</i>	r	<i>Write override:</i>	no
<i>Unit:</i>	n/a	<i>Default value:</i>	no
<i>PDO mappable:</i>	yes	<i>NV storage:</i>	no

In rotary table mode, this parameter contains the actual position of the shaft respect to the zero angular position reached with homing procedure necessary before any rotary table operations. If a table array position has been reached of the table array corresponding to the selected index 5323h.

#### 5.3.40. 5EF0h.0h: Firmware download activation flag

<b>Object:</b>	<b>5EF0h.0h</b>	<b>Firmware download activation flag</b>	
<b>Object Code:</b>	var	<b>Data Type:</b>	unsigned32
<b>Access:</b>	wo	<b>Write override:</b>	operational,power enabled
<b>Unit:</b>	n/a	<b>Default value:</b>	no
<b>PDO mappable:</b>	no	<b>NV storage:</b>	no

This object enable the firmware download on the Twx Motor. Look at §4.9 for the complete procedure.

#### 5.3.41. 1F50h.1h: Firmware download storage

<b>Object:</b>	<b>1F50h.1h</b>	<b>Firmware download storage</b>	
<b>Object Code:</b>	var	<b>Data Type:</b>	visible_string
<b>Access:</b>	wo	<b>Write override:</b>	see text below
<b>Unit:</b>	n/a	<b>Default value:</b>	no
<b>PDO mappable:</b>	no	<b>NV storage:</b>	n/a

This is the object on which the complete firmware has to be downloaded. This object is invisible until firmware download is activated. Look at §4.9 for the complete procedure.

## 6. Beginner's Tips

This section would give to the reader some useful tips and practical examples on the programming basic steps from a factory default configuration to the user application. It would be a practical introduction to the CiA standards and Twx Motor, view from the CAN bus interface level.

User should send the below described COBs on the network via any CAN diagnostic tools, such as the Phase Motion Control's CANdiagno (and CanPC-S1 interface, refer to / 5).

### 6.1. Basic Canbus communication settings and single node setup (Baud rate, Node ID)

In order to create a network of CANopen devices, user has to choose first the **CAN baud rate** (one chosen from [Table 3](#)) that defines the communication speed and then the performance of the network. Faster speed means higher data rate throughput (quantity of data carried per time period) but also shorter overall bus length and less reliability in a high-noise environment. The recommendations for the overall bus length are approximately 30m at 1000kbps, 100m at 500kbps, 250m at 250kbps and 500m at 125kbps (for more information refer to / 4).

In a CANopen network each device must belongs to an unique **node-ID**, in order to uniquely access to any node on the network: then user has to assign node-ID to each device that will be connected on the network.

Those settings have to be done physically connecting one device to the CAN master per time, in order to keep coherency on the CAN bus (if two devices has different baud rate, all the network will be unusable, if two devices has the same node-ID it is not possible to distinguish between two). Then, via LSS (§2.4), user stores the chosen baud rate and node-ID on each node.

As example, this is the sequence of LSS commands to send on the network to set-up a node for 500kbps and node-ID 14 (0Eh):

#### Switch to configuration mode:

COB-ID	B0	B1	B2	B3	B4	B5	B6	B7
7E5h	04h	01h	reserved					

#### Set node-ID:

COB-ID	B0	B1	B2	B3	B4	B5	B6	B7
7E5h	11h	0Eh node-ID	reserved					

**Set baud rate:**

COB-ID	B0	B1	B2	B3	B4	B5	B6	B7
7E5h	13h	00h	02h baud rate	reserved				

**Store configuration:**

COB-ID	B0	B1	B2	B3	B4	B5	B6	B7
7E5h	17h	reserved						

**Switch to normal operation mode:**

COB-ID	B0	B1	B2	B3	B4	B5	B6	B7
7E5h	04h	00h	reserved					

This sequence should be repeated for all other devices. Subsequently, user can connect all devices together on the network.

For further details please look at §2.4 and at / 6.

## 6.2. Configuring an application

We will show two sample applications, the first is a positioner with the necessity of changing the profile velocity dynamically between two consecutive positioning and following error monitoring; the second is a speed-controlled motor with dynamic torque limitation. For both applications we will configure particular PDO (§2.6) mapping, specifically optimized for the function we need, and some parameters. Finally, we suppose to deal with the node configured in the previous chapter, the node-ID 14.

To make all needed configuration we have to access to the object dictionary using SDO (§2.5). From here the notation **xxxxh → yyyyh.zzh** means **download the value xxxh in the object yyyyh.zzh**.

For the first application we have to deal with five parameters: controlword (object 6040h.0h), target position (object 607Ah.0h), profile velocity (object 6081h.0h), statusword (object 6041h.0h) and following error actual value (object 60F4h.0h). The first three are parameters that the master has to send to the Twx Motor for proper operation, the last two are monitoring parameters for the master. As this is not a time-critical application, there is no need to use a synchronized PDO communication, so all RPDOs and TPDOs will be asynchronous on event; in order to avoid bus congestion, we will specify also the inhibit time for the TPDOs.

Here the mappings of all PDOs necessary for this application:

**RPDO #1:**

COB-ID	B0	B1
20Eh	6040h.0h	

**RPDO #2:**

COB-ID	B0	B1	B2	B3	B4	B5	B6	B7
30Eh	607Ah.0h				6081h.0h			

**TPDO #1:**

COB-ID	B0	B1	B2	B3	B4	B5
18Eh	6041h.0h		60F4h.0h			

For the RPDO #1 we can keep the factory setting, it contains just the controlword and has the right transmission type.



For the RPDO #2 configuration first we have to disable it:

C000 030Eh → 1401h.1h

Then we set the asynchronous transmission type (255):

FFh → 1401h.2h

Now we have to change the mapping:

607A 0020h → 1601h.1h

6081 0020h → 1601h.2h

and then write the number of parameters mapped in the PDO:

02h → 1601h.0h

Finally we re-enable the RPDO:

4000 030Eh → 1401h.1h

We can leave the RPDO #3 and #4 enabled or disabled, as we will never use them.

As before this is the sequence for TPDO #1:

C000 018Eh → 1800h.1h

FFh → 1800h.2h

Here we have to specify also the inhibit time: we suppose that we do not want more than 10 feedback PDO per second, then inhibit time will be 100ms, that is 1000 x 100µs:

03E8h → 1800h.3h

6041 0010h → 1A00h.1h

60F4 0020h → 1A00h.2h

02h → 1A00h.0h

4000 018Eh → 1800h.1h

Finally we will disable TPDO #2, #3 and #4 that by default are enabled:

C000 028Eh → 1801h.1h

C000 038Eh → 1802h.1h

C000 048Eh → 1803h.1h

We have still to choose our default application at start-up that is the Profile Position Mode (§3.3):

01h → 6060h.0h

and we need faster acceleration and deceleration ramps (~200 rad/s<sup>2</sup>) than the factory preset values:

0000 2160h → 6083h.0h

0000 2160h → 6084h.0h

Although it is not necessary, we want to permanently store all configurations in non-volatile flash memory:

6576 6173h → 1010h.1h

For the second application we have to deal with four parameters: controlword (object 6040h.0h), target velocity (object 60FFh.0h), speed loop output limiter (object 60F9h.6h) and statusword (object 6041h.0h). The first three are parameters that the master has to send to the Twx Motor for proper operation, the last is monitoring parameter for the master. As previous application this is not a time-critical, then the behaviour of PDOs will be the same.

Here the mappings of all PDOs necessary for this application:

### RPDO #1:

COB-ID	B0	B1	B2	B3	B4	B5	B6	B7
20Eh	6040h.0h		60FFh.0h			60F9h.6h		

### TPDO #1:

COB-ID	B0	B1
18Eh	6041h.0h	

For the RPDO #1 configuration do the following:

C000 020Eh → 1400h.1h

FFh → 1400h.2h

6040 0010h → 1600h.1h

60FF 0020h → 1600h.2h  
 60F9 0610h → 1600h.3h  
 03h → 1600h.0h  
 4000 020Eh → 1400h.1h

For the TPDO #1 configuration do the following:

C000 018Eh → 1800h.1h  
 03E8h → 1800h.3h

The type of transmission and mapping is not necessary here because of the factory default.

4000 018Eh → 1800h.1h

Finally we will disable TPDO #2, #3 and #4 that by default are enabled:

C000 028Eh → 1801h.1h  
 C000 038Eh → 1802h.1h  
 C000 048Eh → 1803h.1h

We have still to choose our default application at start-up that is the Profile Velocity Mode (§3.4):

03h → 6060h.0h

and we have to select the **Enable max position error** bit in the global option flags object, in order to let the shaft stop (if higher braking torque than limit torque is applied) and restart without saturating the Speed control loop:

0005h → 5380h.0h

At last, the store command:

6576 6173h → 1010h.1h

### 6.3. Running an application

The default state of the NMT (§2.9) at start-up is the pre-operational state; to let PDO communication, the node must be switched in the operational state; we suppose to switch all nodes in the network, then the following command has to be issued:

COB-ID	B0	B1
000h	01h	00h

Now, suppose we have configured the Twx Motor with the first example of the previous chapter: we send the following two commands to switch the device control state machine (see Figure 3) from switch on disabled to operation enabled:

COB-ID	B0	B1
20Eh	0006h	

COB-ID	B0	B1
20Eh	000Fh	

At this point the Twx Motor output shaft is powered and the speed loop keep it steady.

We want to make an absolute positioning of 100 turn and 45 degrees with a speed of 2000rpm; first, we calculate the position and the velocity in d.u. (§3.7), that are 0064 2000h and 0222 2222h respectively; then we send those two parameters:

COB-ID	B0	B1	B2	B3	B4	B5	B6	B7
30Eh	0064 2000h				0222 2222h			

Finally, the new set point bit (see Table 13) have to be enabled, in order to let positioning start:

COB-ID	B0	B1
20Eh	001Fh	

At this point motor begin positioning, then the new set point bit could be disabled, in order to let another positioning to be executed:

COB-ID	B0	B1
20Eh	000Fh	

The user could see how statusword and following error actual value changes before and during positioning looking at the TPDO #1 (COB-ID 18Eh).

Now we run the second example of the previous chapter: we send the following two commands to switch the device control state machine (see Figure 3) from switch on disabled to operation enabled, setup zero speed and zero torque:

COB-ID	B0	B1	B2	B3	B4	B5	B6	B7
20Eh	0006h		0000 0000h			0000h		

COB-ID	B0	B1	B2	B3	B4	B5	B6	B7
20Eh	000Fh		0000 0000h			0000h		

At this point the Twx Motor output shaft is powered, but the speed loop cannot keep it steady because we also wrote zero maximum torque.

We want to run the motor at 1500rpm with maximum current of 3Arms: first, we calculate the velocity and the current in d.u. (§3.7 and §4.2), that are 0199 9999h and 3FC9h respectively; then we send those two parameters, together with the same controlword as before:

COB-ID	B0	B1	B2	B3	B4	B5	B6	B7
20Eh	000Fh		0199 9999h			3FC9h		

At this point motor spin up to desired velocity. Note that with the Profile Velocity Mode (§3.4) there is no set point to enable but the target velocity is taken immediately.

As before, the user could see how statusword changes looking at the TPDO #1 (COB-ID 18Eh).

#### 6.4. Factor group setting

The factor group is useful when user need to send reference values (position, speed and acceleration) expressed in multiple of p.u. For example, suppose we have the Twx Motor output shaft connected to a belt, with ratio of 9.6 revolutions (~60.31858 rad) per one meter of belt's linear movement. Now we want to express all reference values in mm, cm/s and m/s<sup>2</sup>.

First, we have to calculate the ratio between belt feeding and motor output shaft, using the relations shown in the §3.7, supposing the gear ratio equal to 1:

$$feed\ constant = 2\pi \cdot gear\ ratio \cdot \frac{\theta[p.u.]}{\theta[rad]} = 2\pi \cdot 1 \cdot \frac{1000mm}{60.31858rad} = 104.16421$$

In order to reduce the overall approximation ratio we express the resulting number as ratio of two large 32 bit numbers:

$$feed\ constant = 104.16421 \cong \frac{7FFFFFFDh}{013A9487h}$$

Now we can download to the proper objects:  
feed constant:

7FFF FFBDh → 6092h.1h

013A 9487h → 6092h.2h

gear ratio is 1 by factory default;

position dimension index, meters:

01h → 608Ah.0h

Position notation index, milli ( $10^{-3}$ ):

FDh → 6089h.0h

Velocity dimension index, m/s:

A6h → 608Ch.0h

Velocity notation index, centi ( $10^{-2}$ ):

FEh → 608Bh.0h

Acceleration dimension index, m/s<sup>2</sup>:

A6h → 608Eh.0h

Acceleration notation index:

00h → 608Dh.0h

Do not forget to store the settings with the command:

6576 6173h → 1010h.1h

For further information refer to [§3.7](#).

**A. Speed control loop schema**

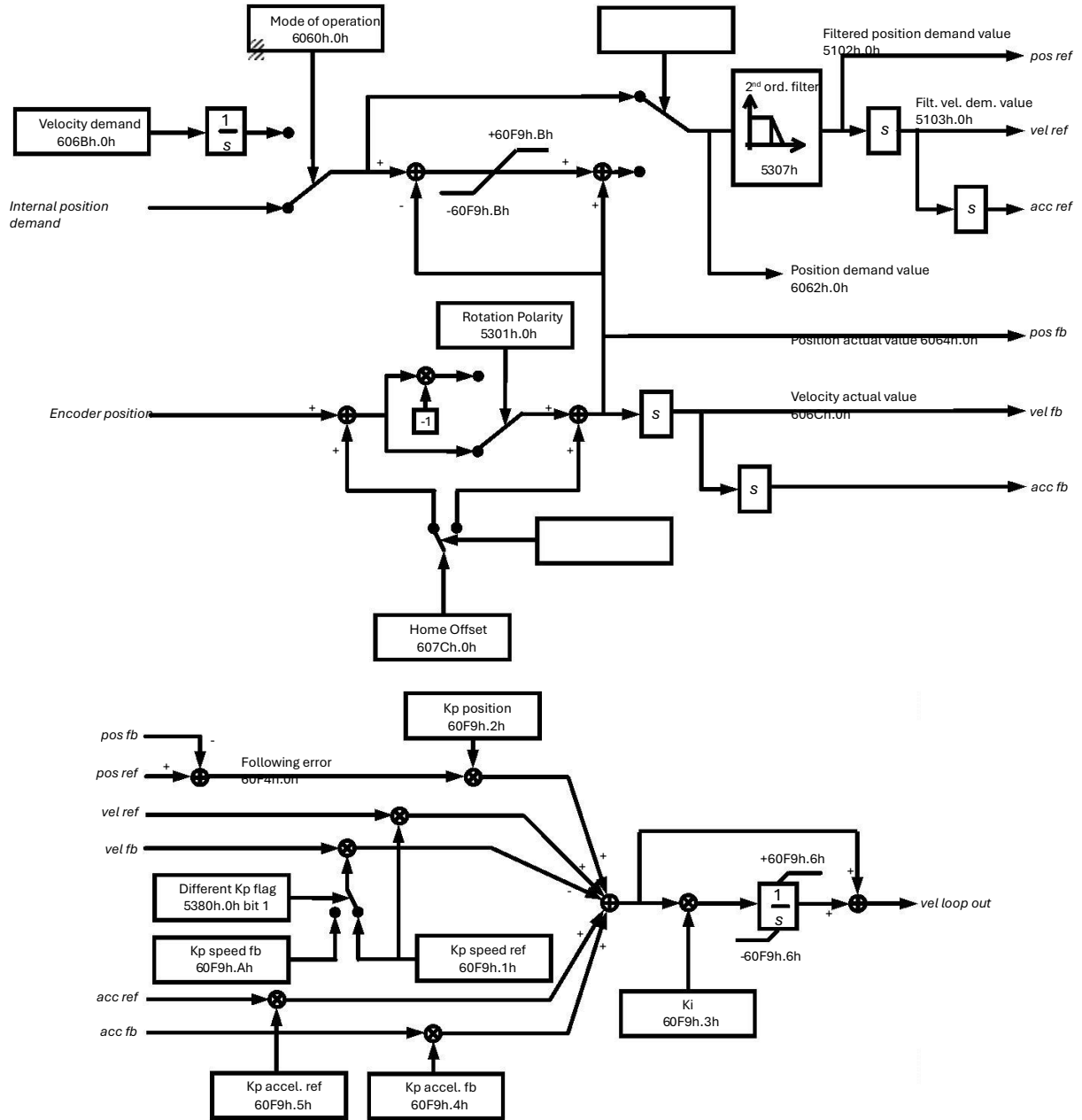

**Figure 21: Speed loop main schema**

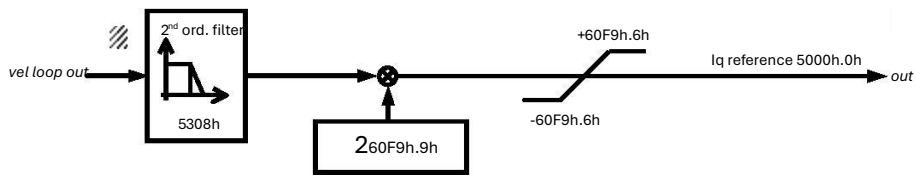

**Figure 22: Speed loop output schema**

For further information refer to §4.5.

## B. Twx Motor default PDO parameters

Those are the default PDO communication and mapping parameters for the Twx Motor:

<i>PDO</i>	RPDO #1		
<i>COB-ID</i>	4000 0200h+node-ID (enabled)		
<i>Type</i>	255 (asynchronous)		
<i>COB-ID</i>	B0	B1	
200h+node-ID	Controlword 6040h.0h		

<i>PDO</i>	RPDO #2		
<i>COB-ID</i>	4000 0300h+node-ID (enabled)		
<i>Type</i>	255 (asynchronous)		
<i>COB-ID</i>	B0	B1	B2
300h+node-ID	Controlword 6040h.0h		Mode of operation 6060h.0h

<i>PDO</i>	RPDO #3					
<i>COB-ID</i>	4000 0400h+node-ID (enabled)					
<i>Type</i>	255 (asynchronous)					
<i>COB-ID</i>	B0	B1	B2	B3	B4	B5
400h+node-ID	Controlword 6040h.0h			Target position 607Ah.0h		

<i>PDO</i>	RPDO #4					
<i>COB-ID</i>	4000 0500h+node-ID (enabled)					
<i>Type</i>	255 (asynchronous)					
<i>COB-ID</i>	B0	B1	B2	B3	B4	B5
500h+node-ID	Controlword 6040h.0h			Target velocity 60FFh.0h		

<i>PDO</i>	RPDO #5					
<i>COB-ID</i>	C000 0000h (disabled)					
<i>Type</i>	255 (asynchronous)					

<i>PDO</i>	RPDO #6					
<i>COB-ID</i>	C000 0000h (disabled)					
<i>Type</i>	255 (asynchronous)					

<i>PDO</i>	RPDO #7					
<i>COB-ID</i>	C000 0000h (disabled)					
<i>Type</i>	255 (asynchronous)					

<i>PDO</i>	RPDO #8
<i>COB-ID</i>	C000 0000h (disabled)
<i>Type</i>	255 (asynchronous)

RPDO from #5 to #8 have no default mapping parameters.

<i>PDO</i>	TPDO #1	
<i>COB-ID</i>	4000 0180h+node-ID (enabled)	
<i>Type</i>	255 (asynchronous)	
<i>Inhibit Time</i>	0	
<i>COB-ID</i>	B0	B1
180h+node-ID	Statusword 6041h.0h	

<i>PDO</i>	TPDO #2		
<i>COB-ID</i>	4000 0280h+node-ID (enabled)		
<i>Type</i>	0 (synchronous acyclic)		
<i>Inhibit Time</i>	0		
<i>COB-ID</i>	B0	B1	B2
280h+node-ID	Statusword 6041h.0h	Mode of op.display 6061h.0h	

<i>PDO</i>	TPDO #3					
<i>COB-ID</i>	4000 0380h+node-ID (enabled)					
<i>Type</i>	0 (synchronous acyclic)					
<i>Inhibit Time</i>	0					
<i>COB-ID</i>	B0	B1	B2	B3	B4	B5
380h+node-ID	Statusword 6041h.0h	Position actual value 6064h.0h				

<i>PDO</i>	TPDO #4					
<i>COB-ID</i>	4000 0480h+node-ID (enabled)					
<i>Type</i>	0 (synchronous acyclic)					
<i>Inhibit Time</i>	0					
<i>COB-ID</i>	B0	B1	B2	B3	B4	B5
480h+node-ID	Statusword 6041h.0h	Velocity actual value 606Ch.0h				

<i>PDO</i>	TPDO #5
<i>COB-ID</i>	C000 0000h (disabled)
<i>Type</i>	255 (asynchronous)
<i>Inhibit Time</i>	0

<i>PDO</i>	TPDO #6
<i>COB-ID</i>	C000 0000h (disabled)
<i>Type</i>	255 (asynchronous)
<i>Inhibit Time</i>	0

<i>PDO</i>	TPDO #7
<i>COB-ID</i>	C000 0000h (disabled)
<i>Type</i>	255 (asynchronous)
<i>Inhibit Time</i>	0

<i>PDO</i>	TPDO #8
<i>COB-ID</i>	C000 0000h (disabled)
<i>Type</i>	255 (asynchronous)
<i>Inhibit Time</i>	0

TPDO from #5 to #8 have no default mapping parameters.

### C. Twx Motor default control parameters

Those are the factory default values for some objects hardware configuration dependant (object 5311h.0h).

Object	Absolute Encoder ( <b>N</b> and <b>M</b> )	Two-poles Resolver ( <b>R</b> )
60F9h.9h: Velocity control – Output Scaling Magnitude	4 ( $\times 2^4$ )	3 ( $\times 2^3$ )
5308h: Velocity loop output filter constants	None Costants: 0,0,0,0,8192	LPF, $\omega_0 = 630 \text{ rad/s}$ , $\xi = 0.707$ Constants: -6564,14575,45,91,45

Table 36: Default control parameters

### D. Physical units vs. internal device units conversion

Current:	$I[d.u.] \approx 5.443 \cdot 10^3 \cdot I[Arms]$	$I[Arms] \approx 1.837 \cdot 10^{-4} \cdot I[d.u.]$
Position:	$\theta[d.u.] \approx 1.043 \cdot 10^4 \cdot \theta[rad]$	$\theta[rad] \approx 9.587 \cdot 10^{-5} \cdot \theta[d.u.]$
Velocity:	$\omega[d.u.] \approx 1.709 \cdot 10^5 \cdot \omega[rad_s]$	$\omega[rad_s] \approx 5.852 \cdot 10^{-6} \cdot \omega[d.u.]$
Acceleration:	$\omega\ddot{d.u.}] \approx 4.272 \cdot 10^1 \cdot \omega\ddot{[rad_s^2]}$	$\omega\ddot{[rad_s^2]} \approx 2.341 \cdot 10^{-2} \cdot \omega\ddot{[d.u.]}$

## Support contacts

For any support /repair request or information, please use our online support form at

<https://www.phase.eu/repair-request/>

Direct Support E-mail contacts:

[support@phase.eu](mailto:support@phase.eu)

For electrical issues

[repair@phase.eu](mailto:repair@phase.eu)

For repair requests

[customercare@phase.eu](mailto:customercare@phase.eu)

For other requests

For quick and efficient help please have the following information ready: » Detailed description of the fault and the circumstances » Information on the type plate of the affected products, especially type codes and serial numbers



It is not allowed to reproduce, copy, store, forward and transmit, any part of this publication, in any support and physical or digital format, without the prior written permission of Phase.

No patent liability is assumed with respect to the use of the above informations. Moreover, because Phase is constantly striving to improve its high-quality products, the information contained in this manual is subject to change without notice.

Every precaution has been taken in the preparation of this manual. Nevertheless, Phase assumes no responsibility for errors or omissions. Neither is any liability assumed injuries or damages resulting from the use of the information contained in this paper.

---

## Trademarks

TWX, TorqueWire, are trademarks or registered trademarks of Phase Motion Control in Italy and other Countries

- Windows, Windows XP, Windows Vista, Windows 7, Windows 8, Windows 10, Windows 11, Windows 12 and Excel are registered trademarks of Microsoft Corporation in the USA and other countries.
- Canopen/EtherCAT® are registered trademarks and patented technology, licensed by respective owners.
- ODVA, CIP, CompoNet, DeviceNet, and EtherNet/IP are trademarks of ODVA.

Other company names and products names in this document are the trademarks or registered trademarks of their respective companies

---

## © Copyright

All rights reserved.

No part of this publication can be reproduced, stored, or transmitted, in any form and with any system, mechanical, electronic, photocopying, recording, or otherwise, without the prior written permission of Phase Motion Control.

No patent liability is assumed with respect to the use of the information contained herein.

Additionally, because PMC is constantly enhancing its high-quality products, the information contained in this manual is subject to change.

**PHASE MOTION CONTROL S.P.A**  
HEADQUARTERS - Via Luigi Cibrario 4, 16154  
Genova, Italy  
Phone +39 010 835161