

TK Series frameless motors installation and application manual

DRAFT

Rel 2.8 doc MA0012.6 ENG

Phase Motion Control S.p.A.

Headquarters and legal address: Via Luigi Cibrario, 4, 16154 Genova, Italy

Warehouse: Via Pionieri ed Aviatori d'Italia, 4, 16154 Genova, Italy

Ph: +39 010 83 51 61

Fax: +39 010 420 67 36

e-mail: info@phase.eu

<http://www.phase.eu>

TABLE OF CONTENTS

TABLE OF CONTENTS.....	2
Introduction	4
Safety	4
General safety instructions.....	4
Electrical risk.....	5
Transport and storage conditions	6
Transport and packaging.....	6
Unpacking and mounting.....	6
Storage.....	6
Transportation	7
General technical information on TK frameless motors.....	8
Thin ring, large diameter motors for high torque, low speed (torque motors)	9
Spindle motors for mills and lathes	10
Tube motors, small diameter, for multiple spindle units	10
Selection guidelines.....	11
How to choose the optimal TK motor?.....	11
Motor morphology and protections.....	13
TK Motors codification.....	13
TKST stator description.....	13
Type and manufacture of TK motors	16
Insulation voltage	17
Over temperature protection.....	18
Ground connection	18
Standard type and size of output power leads	19
Anti-resonance filter (snubber).....	19
How to measure the voltage spikes	20
Motor integration	244
Stator	244
Rotor.....	255
Mounting of the rotor inside the stator	256
Radial force vs. mounting eccentricity	266
Check list after integration	277

DRAFT



Introduction

The present document detail the installation, integration, and initial mechanical set-up of PHASE MOTION CONTROL series TK frameless torque motors (henceforth named TK motors). It provides the customer with the necessary information on how to integrate and operate with TK in his application.

Remark: The liability of PHASE MOTION CONTROL is in all events limited to the functionality of the motor alone and is limited to its repair or replacement according to the rules agreed in the "documento Condizioni Generali di vendita Phase Motion Control", www.phase.eu, which are implicitly accepted when the motor is purchased.

Frameless motors are just components, however important, of complex systems of which Phase Motion Control is not aware and not responsible. The Customer or whoever owns or operates the system must take the responsibility to assess all safety or economical concerns relevant to the complete system, over and beyond motor replacement, which may stem from any type of motor failure, and of which Phase Motion Control is unaware and is not and cannot be responsible.

Safety

The user must have read and understood this documentation before conducting any activity. In case of unclear information, please contact PHASE MOTION CONTROL.

Handling, installation, and maintenance must be done by competent and trained technical personnel according to IEC 364. Non-compliance with the safety instructions, statutory and technical regulations may lead to injuries to persons, damage to property and the environment.

General safety instructions



Anyone having active implants (pacemakers) or having any other ferromagnetic prosthesis is not qualified to work with these kinds of devices, or to approach them. Keep at safe distance from the motor!



Electronic devices and measuring equipment may be affected or destroyed by strong magnetic fields. Avoid placing devices with magnetic parts close to computers, monitors and all magnetic data carriers (e.g. disk, credit cards, audio and videotape, etc). Because of strong attraction forces, special caution is required in the direct proximity of the rotor (i.e. under 100 mm). Therefore, heavy or wide objects made of steel or iron must never be brought close to the rotor by free hand. As magnetic forces are invisible, their effects are generally overlooked close to the rotor.



To cope with any event of an accident while handling the motor, always have at hand at least two wedges of solid, non-magnetic material (i.e. aluminium) as well as a non-magnetic hammer (approx. 2-3 Kg). In emergency cases, these tools are for separating parts magnetically attached to the rotor in order to free caught limbs (finger, hand, foot).



Electrical risk

Before installation verify the motor about any damage due transportation and handling, that may impair electrical safety.

Drive start-up may produce sudden uncontrolled movement. Keep away from all moving parts to avoid injury!

Do not connect motor to power supply other that specified by PHASE MOTION CONTROL.

A defective power supply may damage the TK assembly.

It is dangerous to interrupt earth or grounding connections. In no way must an earth wire be disconnected!

Before servicing, make sure that the TK is not powered.

TK motors may have hot surfaces also when the motor is not powered. Normal operating temperature could be over 100°C.

Slow turning motors have high back-EMF. For example, a TK-xxx-xxx-100 would develop 300 Vac at its terminals when manually rotated at 5 rpm. Beware of manual or gravitational rotation, dangerous voltage can be present at the motor terminals even if the machine is not connected.

WARNING: Deep deflux motors (constant power range > 1:2) may deploy higher than mains voltage between motor and series inductor. Verify maximum interconnection voltage while sizing the plant.

DRAFT



Transport and storage conditions

Transport and packaging

The PHASE MOTION CONTROL standard package is designed to avoid transport damage.

If any transport damage is observed upon reception of the goods, please inform immediately Phase Motion Control so that transport damages can be timely claimed or corrected.

Unpacking and mounting

To unpack the TK, please adopt all general safety instructions, reported on the paragraph 3.1.

After opening the package, never pull the motor cable, nor lift the motor by its cables.

Check for cable damage during transport or unpacking

For handling of heavy motors (i.e. >15Kg) the use of lifting tools is recommended, using threaded lifting bolts, when possible, or using a lift belt.

When storing the motor outside the original packaging put a non-magnetic spacer (i.e. wood) with 40-mm minimum thickness between stator and rotor.

After unpacking the rotor, keep the original rotor wrapping or wrap the magnetic part of the rotor with paper tape, to keep the magnetic surface clean. The tape must be removed just before mounting the rotor into the stator.

Take care with the rotors banded with carbon fibre ring: an accidental contact with metallic parts attracted by the magnetic field can cause damages to the carbon ring, if this happens please contact PHASE MOTION CONTROL.

Do not leave the rotor outside of its package longer than necessary for assembly to prevent pollution of the magnet surface and accidents

After mounting verify that the rotation of the rotor inside the stator is free, without contact for the whole revolution.

Storage

The storage area of TK motors must be strictly restricted and indicated with "Caution, powerful magnets".

Motors and motors parts, whenever possible, should be stored in the original packaging.

The storage air humidity should be between 5 and 80% and the temperature between 5 and 45°C.

Should components be stored outside their original packaging, wrapping with oiled paper to prevent corrosion is recommended.

Magnetic parts should be separated and wrapped in non-magnetic protection. These protections should be at least 40 mm thick.

Transportation

By land:

The motor must be shipped with original packaging; if it is not possible use IP54 protection packaging. The parts must be packaged firmly to avoid any movement in case of shocks.

By sea:

Use only sea standard packaging (IP55).

By air:

CAUTION: if the rotor must be shipped unassembled, i.e. not inside the stator, airline authorisation is required because of the stray field of the rotor. The use of the original iron box in which the rotor was supplied is recommended. As required, enquire with Phase Motion Control for the supply of a shielding box.

DRAFT



General technical information on TK frameless motors

The TK series of frameless brushless motors provide the highest torque density available today for direct drive, high performance applications. Unlike traditional torque motors, TK units have both high torque and high speed capability and thus operate seamlessly both as spindle and table motors.

TK motors consist of separately supplied stator and rotor units suitable for direct assembly inside the structure of the machine. TK motors are three phase, rare earth (Iron Neodymium Boron) permanent magnet units and reach the highest continuous and peak torque density available today, together with high speed and flux control ability over a constant power range up to 10:1.

The rotors use special manufactured magnets with minimized loss factor allowing high speed operation with a thin isotropic rotor. All rotors are rigid units with mechanical, glue free magnet retention, preloaded carbon fiber sleeve for safe operation even at very high speed.

Rotors are often semi custom units to allow direct coupling to bearings, encoders, brakes.

All TK motors are designed for fluid (water) cooling on the outside of the stator for maximum performance. Conduction/convection cooling is also possible. Constant power operation (flux control) always requires water cooling.

Customized frames with integral cooling or even partial machine subassemblies with bearings and encoders are manufactured on request based on the standard frameless magnetic designs available.

The torque range spans from 10 to 40,000 Nm with maximum diameter 1150mm; above that size, segmented semi custom units are available, currently up to 18 m diameter.



Typical applications:

Metal cutting	DD rotary tables with both contouring and turning ability; DD spindles for mills and lathes; Tubular spindle motors for multi spindle machines; Rotary table indexing for transfer machines;
Metal forming	DD flywheels for press; Cold rolling machines; DD Capstans for hot and cold rolling/drawing;
Plastic	DD extruders; Injection and mixing stages for plastic injection molding machines; Gearbox suppression in mixer, grinders, shredders;
Energy	PM generators for small steam or gas turbine, cogeneration; Micro Hydro-generators; Wind turbines;

Depending on their geometry and magnetic circuit, TK motors can be divided into three main branches:

Thin ring, large diameter motors for high torque, low speed (torque motors)

Typical applications:

- Rotary tables for NC machine tools, often with turning capacity
- Indexers for transfer machines
- NC machine head orientation
- Large rotary tables (glass, packaging, assembly)
- Carbon fiber deposition machinery
- Direct drive of mills (concrete, ceramics, rubber)
- Large low speed generators (mini hydro, wind power)
- Metal forming: electric press and bending
- Direct drive plastic injection machines



In all these applications, direct drive eliminates play and removes the need of an accurate mechanical gearbox, which in turn would limit the accuracy and the dynamic performance of the system. Mechanical brakes-dividers are unnecessary. The table accuracy is the accuracy of the encoder system. The system is thus extremely simple, flexible and reprogrammable. The removal of the transmission system and of its backlash and elasticity results in control bandwidth up to 250 Hz, so that a positioning cycle can be completed with great accuracy within a few msec with advantage on the machine cycle time.

To ensure adequate servo performance in direct drive high accuracy, high stiffness applications such as indexing and rotary tables in NC machine tools, the sensor must be sinusoidal so that the drive may interpolate the actual position with a resolution at least ten times greater than the required accuracy.

Additionally, the sensor fastening or spring mount must have intrinsic resonance frequency above 2000 Hz not to limit the overall system performance.

Spindle motors for mills and lathes

long and thin motors, brushless with flux control ability, medium to high speed, high power density, suitable for heavy machining or control of large inertia loads for spool winding/unwinding. The TK motors have currently the highest power density and allow the manufacture of electrospindles with torque rating hitherto unattainable, in the range of several thousand Nm while reaching high speeds in the thousands of rpm.

Spindle type motors are anyway high performance servo motors so another emerging application area is very short cycle actuation. Recent applications are in direct drive of the ram of high speed turret punching press with stroke rates in excess of 300 strokes/min, or fast, heavy indexing in wire frame welding machines.

Typical applications:

- Power lathes for automotive,
- Spindle motors for mills and high speed machining centers
- Wire grid manufacturing

Tube motors, small diameter, for multiple spindle units

Typical applications:

- High speed/power motors where lateral (pitch) space is limited
- Multiple drilling heads
- Swiss type lathes



Selection guidelines

How to choose the optimal TK motor?

First, define the technical feasibility of the application. In general, all motors share the same physical limitation, that is, the ability to generate “airgap thrust”, i.e. a sideways thrust between stator and rotor which is linear thrust in linear motor, and becomes a torque when the motor is round. The amount of thrust per unit area depends on motor technology but is fundamentally limited by the properties of the materials (magnets, copper, steel) used in the motors. PM technology offers the highest specific thrust available today, and this value is gradually increased as the technology improves. Many factors (cooling conditions, size, air-gap thickness, linear speed etc.) affect this value which should only be used as a rough guideline. TK rotary motors are characterised by a peak thrust around 90000 N/m², continuous thrust with water cooling ~ 55000 N/m².

The thrust limitation explains why it is always appropriate to use the maximum diameter available to maximize output torque. In general, if a motor is scaled in diameter, torque is scaled with the square of diameter, while it scales only linearly in length. Consequently, to verify whether a new application is feasible at all, if the torque availability is expected to be a limitation, the maximum diameter available should be determined compatibly with physical limitation and maximum peripheral speed (values below 150 m/sec pose no problem) and the air-gap surface can then be evaluated. This would give a rough estimate of motor length and therefore indicate whether the application is feasible or not.

A typical power and torque curve versus speed is shown in Fig.1 for a combined torque/spindle motor with 570 mm diameter, 100 mm axial length; in Fig. 2, the motor temperature at no load and full loads are displayed. It can be observed that above the “knee speed” i.e. the speed of transition between constant torque and constant power operation, the motor temperature becomes progressively independent of motor load.

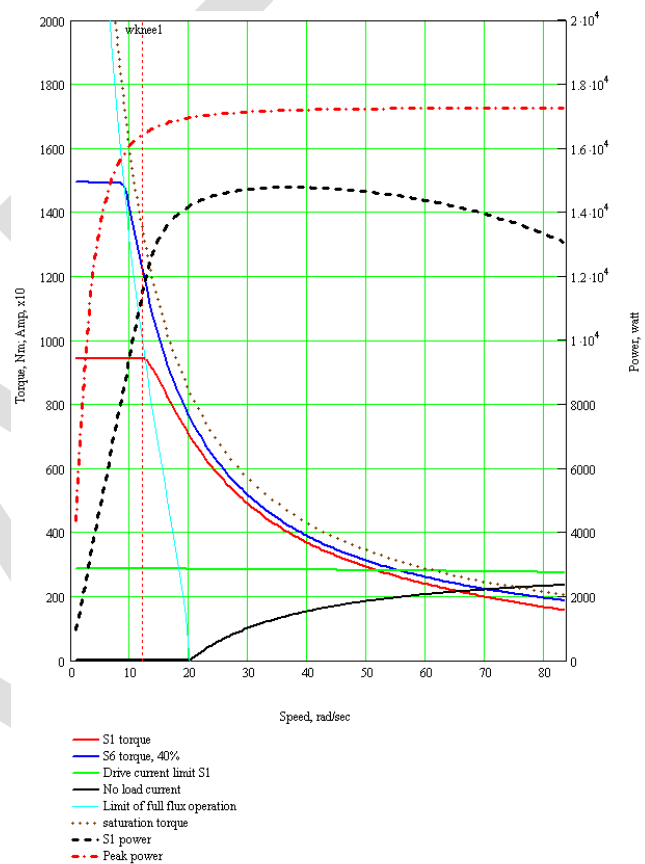

Fig. 1: typical power and torque curve vs speed

Large rings with very limited axial length are the most efficient solution for **high torque low speed applications**, and they have the additional advantage of not needing separate bearings as they can be generally carried by the same bearings of the load. However, inertia scales with the cube of diameter, so **where the inertia is the dominant load, long and thin motors are more appropriate**. A typical example is the direct drive of the ram of high speed punch presses, in which motion is reversed over 300 times/min, or in high speed flying shears; in this case, tubular, water cooled TK motors provide the highest performance solution.

Spindle drives generally demand both high torque and high speed but the diameter is generally restricted, so they tend to be long and thin. Air-gap hole diameter to length ratios up to 1:3 are routinely manufactured. In this case, the Phase PM magnet technology allows the manufacture of extremely **thin stators and rotors** which are particularly useful in **multispindle** applications.

Spindle PM motors manufactured with the high frequency Phase magnetic technology can operate both in constant torque and constant power mode.

The constant power range, depending on the type, can exceed 10:1 although this is generally limited by the ability of the drive selected to control a deep deflux range. When compared to AC Induction spindle motors, the PM motor design offers:

- Rated torque approximately double in the same size
- Larger shaft compared to the outer diameter
- Loss only limited to stator, rotor is “cool” so that bearings can operate more accurately and reliably
- Solid, “mechanical” rotor (non laminated) which guarantees balancing stability
- Wide constant power control range (up to 10:1) without tap change
- Free from radial flux which may generate currents in the bearings

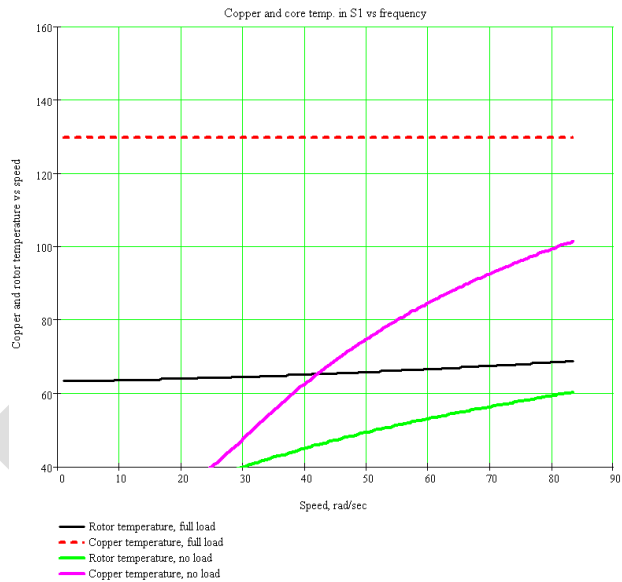

Fig. 2: motor temperature at no load and at full load vs speed

In the Phase TK technology, there is no fundamental physical difference between torque motors and spindle motors; they have the same smoothness and high bandwidth necessary for direct drive indexing and contouring operation, so that **milling and turning operations on the same motor are now possible.**

There is, however, a fundamental difference between PM and induction spindle drives. In the induction technology, power is used to magnetize the motor (at low speed, high torque) thus resulting in limited output torque available; flux reduction is easily obtained by just reducing the magnetizing current. Thus, the motor is “hot” at max load, and “cool” at no load. PM motors, conversely, derive the field from high energy permanent magnets, so that no power is required to build the motor field and more power can be devoted to torque generation. When the flux must be reduced, however, power must be applied just to lower the field so that PM motors at high speed need some current even at no load.

Another useful feature of PM technology is the ability to operate with a **wide air-gap**, up to several millimetres in the larger motors. This feature can be useful in machines with important deformations, such as plastic injection press or impact hammers. As a standard the air-gap is in the order of 1 mm, radial, and this generally enables designs in which the motor rides on the machine supports without need of separate bearings.

Motor morphology and protections

PHASE MOTION CONTROL TK brushless motors are the technical solution with the highest torque density currently available and are designed for high performance motion control.

Tk motors are frameless and are supplied as separate stator and rotor units for integration into the final equipment. The motors are all three phases brushless, and the rotors are based on rare earth, high energy FeNdB magnets.

TK Motors codification

TK motors consist of two main components one stator (TKST) and one rotor (TKRT). When ordering a TK motor, the two parts have different codes. The general codification system of TK parts is as follows:

Stator TKST.XXX.YYY.ZZZ.K

where:

- XXX = Stator outer diameter
- YYY = Active part length
- ZZZ = Approximate Torque Constant
- K = Version

Rotor TKRT.XXX.YYY.K

where:

- XXX = Stator outer diameter
- YYY = Active part length
- K = Version

TKST stator description



A three phase stator, wound and vacuum encapsulated in super high thermal conductivity compound (for low surface temperature operation) or impregnated (3 dips, preferred solution for high thermal cycling), which is either built into a metallic frame carrying the cooling chambers and coupling O-Rings on the outside and a set of tapped holes on one side (SQUID type), or into a thin steel microframe, cylindrical.

The standard SQUID frame is much simpler to use and only requires a cylindrical cavity, while motor assembly and fastening is just through a set of screws. The cooling circuit channels are designed by Phase Motion Control in order to maximize heat exchange and simplify integration in customer machine.

Alternatively, the microframe units are ground to h7 tolerance on the outside diameter and are machined parallel on the two stack sides. This construction is intended for interference fit or axial pressure locking. The microframe technology maximizes the usage of space in the assembly and requires the machine body to carry the cooling cavities on the inside. It requires some care in the design of the application.



The insulation system of the motors is rated Class H (magnet wire: Class C) with reinforced insulation specifically designed for the high DV/dt typical of 600 Vdc servo drive application; the windings are equipped with thermal sensors and thermal protectors as detailed later in this document.

The star point of the winding is also generally available for filtering purposes.

TKRT rotor description

A Permanent Magnet Rotor, with tubular, isotropic base shape, which carries the magnets on the outside periphery, protected by a preloaded carbon fiber (up to 150 m/sec) ring.

The magnets are generally high temperature, high energy FeNdB sintered magnets, Phase Motion Control manufactured with a special patented technology. They are designed for the maximum class temperature and are virtually impossible to demagnetise except in case of drive failure or improper operation. If continuous exposure to oil is forecast, special oil resistant magnets can be specified.

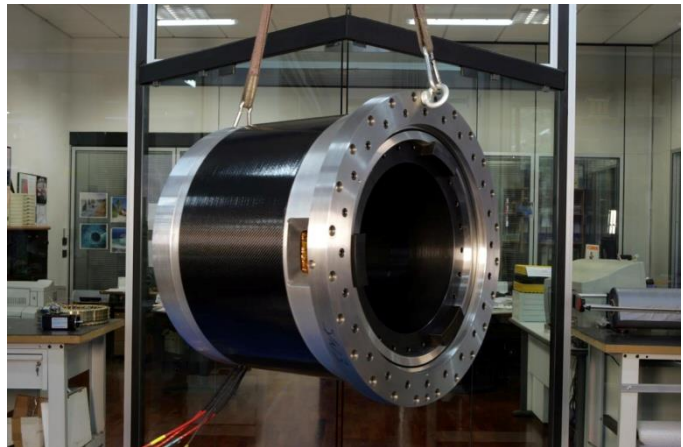

The rotor may be fastened on the shaft either by interference fit or by an array of axial bolts. The latter construction is preferred for high torque, low speed applications such as rotary tables. In general, the rotor inside profile is customised to fit with the needs of the machine provided the required profile is compatible with the maximum hole required by the magnetic field, and specified in the accompanying technical sheets. For proper operation, the motors need a position sensor on the shaft (not supplied) both for field orientation and for position/speed control. The rotor is permanent magnet type and has no primary losses, so that no rotor cooling is needed in principle. However, the inverter chopper frequency must be set high enough to ensure that the ripple current, pk-pk is less than 20% of the nominal rms current to avoid the insurgency of unacceptable, and dangerous, stray rotor loss.



For **TK motor until and included size TK1340**, we apply phosphating treatment on rotor iron part and stator steel frame.

This will be done by default and included in the supply unless different requests

Customized frames with integral cooling or even partial machine subassemblies with bearings and encoders are manufactured on request based on the standard frameless magnetic designs available.

Type and manufacture of TK motors

TK motors can be supplied in the following types:

Stator	Standard SQUID (water cooling jacket)	The stator is inserted into a frame, designed on customer specification, for liquid cooling using internal chambers or using the external surface. The frame carries fixing holes for interfacing with the driven machine. O-Ring sealing can be included in motor supply according to customer request.	
	Closed SQUID frame (Optional)	Same as standard SQUID design, but the external cooling circuit is closed with a special water proof carbon fibre sleeve. This option is available in pre-defined motor diameters.	
	Microframe (Optional)	Inserted on thin steel sleeve machined to h7 tolerance, suitable for hot assembly on the operating equipment	
Rotor	Carbon fibre (standard)	<p>Tubular ring with magnets, with carbon fibre sleeve for peripheral rotation speed from 50 to 150m/s. Shaft assembly is performed on the internal tube diameter generally ground to H6 tolerance. Shaft interface can be selected between:</p> <ul style="list-style-type: none"> • screw mounting (standard); • interference mounting w/ or w/o oil pressure chamber (opt.); • locking rings seats (opt.); <p>Standard TK motor rotors are not pre balanced; final balancing, if necessary, must take place after rotor assembly on the shaft. Pre-balancing is available on request (optional).</p>	

PHASE MOTION CONTROL, together with the Customer, often achieve higher level of efficiency and performance by designing and supplying semi-custom variants of the TK motors with special winding, rotor and frame designs.

TK motors express their maximum performance in liquid cooled version. Nevertheless, they can be calculated also for conduction/convection cooling where the performance is defined together with the customer depending on the available external cooling surface.

For high speed and field weakening operation liquid cooling is necessary

Motor encapsulation or impregnation

All the stators' windings of TK motors are encapsulated under vacuum with high thermal conductivity epoxy resin to provide the best mechanical characteristics, protection, insulation, and thermal transfer.

For special application (extra-low weight, very aggressive chemical agents...) the stator can be provided with impregnation varnish instead of encapsulation.

Insulation voltage

All TK PHASE MOTION CONTROL motors are tested with following parameters:

Insulation voltage between Phases-GND	4,5 KVDC 60s
Insulation voltage between Phases - Thermal Sensors	3,5 KVDC 60s
Insulation voltage between Thermal Sensors - GND	3,5 KVDC 60s

Wires and connectors

All standard TK motors are supplied with power and sensor wire length 1000mm, different length on request.

With custom frames also power and signal connectors can also be supplied.

TK motors are supplied without position sensors.

Over temperature protection

All TK PHASE MOTION CONTROL motors are supplied with two types of sensors: two PT1000 and three PTC 130 or PTC 155.

The PTC130 sensors (blue/blue wires) or PTC155 sensors (blue/black wires) are localized one on each phase, so can react very fast when the temperature rise of the winding exceeds the tripping threshold in any one phase. PTC sensors MUST be used for protection. The PTC sensors are highly non linear, so they are sensed via a threshold circuit. The sensors guarantee <750 Ohm resistance for $T_w < 125$ C, and >4000 Ohm resistance for $T_w > 145$ C.

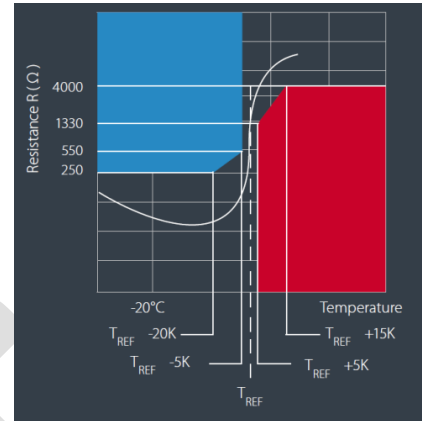

PT1000 sensors have double insulation to the winding.

All TK stators have two PT1000 sensors. The customer can use either one of them indifferently. Should a KTY probe fail for any reason, the other one can be used without need for repair.

The PT1000 sensor (white/red wires) is a linear temperature sensor and provides a reading of actual stator winding temperature (see figure), which must be used for monitoring and verification of the motor temperature during the cycle. It is NOT a protection, because it is localized on only one point and cannot guarantee true information, when a localized overcurrent occurs on a zone far from the PT1000.

PT1000 sensors are polarized, be sure to respect the +/- wires assignment at installation.

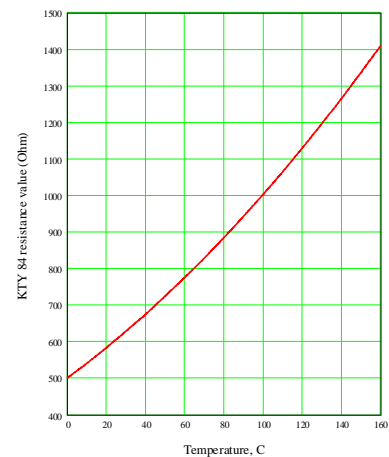
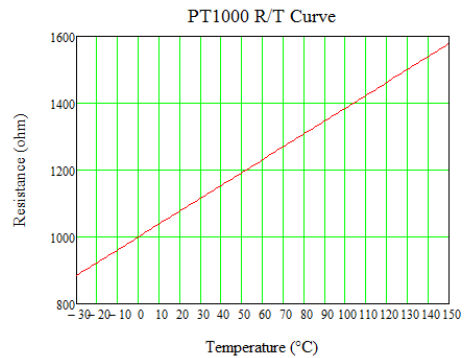

KTY84-130 sensors (out of production) are available on request in place of PT100 sensors. The behaviour is similar just with a different R/T characteristic.

Ground connection

Rotor and stator must be connected to the ground. Do not energize before connecting the grounding terminals.

Standard type and size of output power leads

Standard TK motors power leads have Radox 155 insulation for best mechanical and thermal resistance. Cables exiting from the stator must be kept as short as possible in order to limit the risk of damage during handling and transportation.

Typical output cable cross-sections are as follows:

Nominal current	Wire size	Cable diameter
$I_n < 10$ Arms	1 mm ²	2.7 mm
10 Arms $\leq I_n < 14$ Arms	1.5 mm ²	2.85 mm
14 Arms $\leq I_n < 21$ Arms	2.5 mm ²	3.5 mm
21 Arms $\leq I_n < 28$ Arms	4 mm ²	4.2 mm
28 Arms $\leq I_n < 40$ Arms	6 mm ²	5 mm
40 Arms $\leq I_n < 60$ Arms	10 mm ²	6.4 mm
60 Arms $\leq I_n < 90$ Arms	16 mm ²	7.6 mm
90 Arms $\leq I_n < 115$ Arms	25 mm ²	9.2 mm
115 Arms $\leq I_n < 150$ Arms	35 mm ²	10.6 mm
150 Arms $\leq I_n < 200$ Arms	50 mm ²	12.4 mm
200 Arms $\leq I_n < 250$ Arms	70 mm ²	14.85 mm
$I_n > 250$ Arms	95 mm ²	16.6 mm

Anti-resonance filter (snubber)

In some conditions of the power supply chain, electrical resonance phenomena may occur in motor windings. These phenomena can multiply several times the instantaneous voltage of winding versus ground, leading to excessive stress of the motor insulation system resulting in quick degeneration and total insulation failure after a short time of operation.

Picture below shows the star point voltage versus ground waveform acquired in a system with significant resonance. The DC-Bus setting of the power amplifier is only 600 Vdc but the instantaneous voltage can reach a value as high as 1600 V. The insulation system cannot withstand this high voltage in long term operation.



To limit such voltage transients, Phase supplies with each motor with such characteristics a tuned anti resonance filter (snubber) which must be assembled within 5 m of the motors, between the motor star terminal (white wire) and machine ground. Failure to connect the snubber may result in motor failure by insulator puncturing.

With actual motor insulation the limits are:

- Star point – GND 2400 Vpk-pk (1200 Vpk refer to zero)
- Phase – GND 2400 Vpk-pk (1200 Vpk refer to zero)
- Star point – Phase 2400 Vpk-pk (1200 Vpk refer to zero)
- Max dV/dT 6 kV/μsec in all the conditions

How to measure the voltage spikes

Instruments required: Oscilloscope, High voltage probe



-Disable completely the drive and any active power source before performing any operations on the motor terminals and make sure there is no residual voltage.

-The common mode voltage measurements (especially without snubber) with locked rotor expose the winding to high voltage spikes, so the system should be kept in this condition for the shortest time possible.

It's important to disable the drive between measurements, and to keep it enabled only for the time it takes to adjust the timescale and voltage scale on the oscilloscope and freeze the display.

Introduction

The system motor + cabling can be modelled, in the high frequency field, as a delay line with distributed inductance and distributed stray capacitance. This is not an issue in the 50-60 Hz world but can be (and often is) an issue when you have very high frequency harmonics due to inverter switching. The wavefronts of the PWM travel through the system until they reach the end of the line and can be reflected if the line is not terminated. In some events, which depend on inverter switching speed (IGBT type), cable length and capacitance, motor inductance, these phenomena can multiply several times the instantaneous voltage of winding versus ground, leading to excessive stress of the motor insulation system resulting in quick degeneration and total insulation failure after a short time of operation.

For this reason, in PMC's motors (especially in prototype units) the star point connection, which is the end of the line, is always made accessible through a dedicated wire. If dangerous spikes are found, this is the point where we can connect a damping termination (snubber).

If, after measures, it is determined that the star point filter is not required, the star point connection can be removed in production units.

Measurement procedure

As described above, the best point to measure the amplitude of voltage oscillations is at star point connection.

The presence of the star point wire (typically this is a black 1 mm² wire) is normally indicated in the cabling diagram in the motor assembly drawing as in below example:



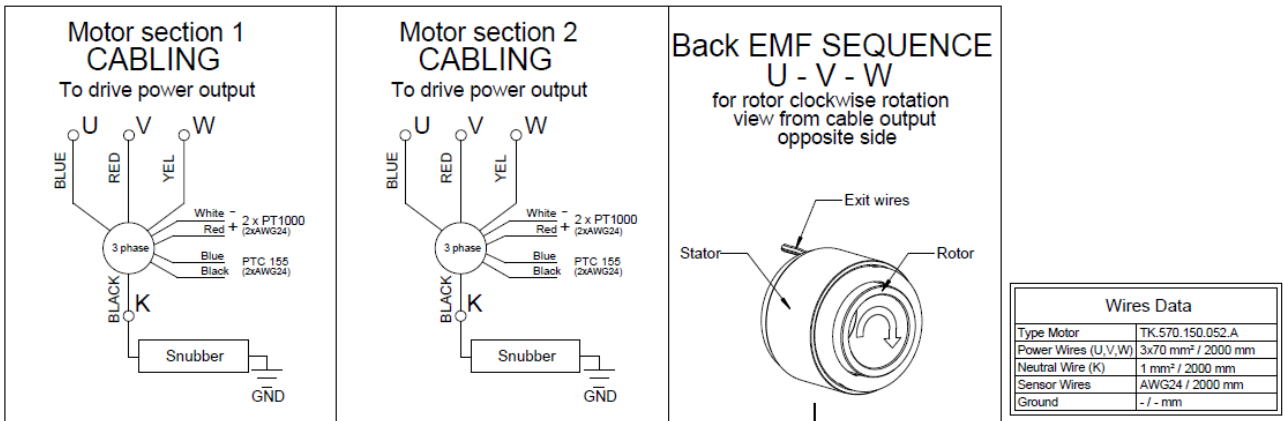

As already stated, the star point potential to GND can have transient values as high as 1000 Vpk and above. It is very important that this wire is kept well isolated from GND and from other connections.

For the same reason to measure these transient voltages it is necessary to use an adequately isolated oscilloscope and/or voltage probe.

Our normal equipment is as follows:

- Oscilloscope Tektronix THS3014 + probe 1:100 Fluke VPS410-R

Or:

- Tektronix oscilloscope + Differential 2500 V isolated probe

The measurement is executed by connecting the probe between star point wire and GND.



Be sure that all power is switched off during the connection operation. Very high voltage can be present at star point terminal when the drive power is on.

The oscilloscope time scale should be set to acquire approximately 10 PWM cycles (for instance 1250 μ s @8 kHz PWM frequency or 2500 μ s @4 kHz PWM frequency). The voltage scale should be set to 500 V/div.

After connecting the oscilloscope, power on the drive and enable the motor with no torque and no motion (just enabled PWM).

Picture below shows an example of star point voltage versus ground waveform acquired in a system with significant resonance. The DC-Bus setting of the power amplifier is only 600 Vdc but the instantaneous voltage can reach a value as high as 1600 V.

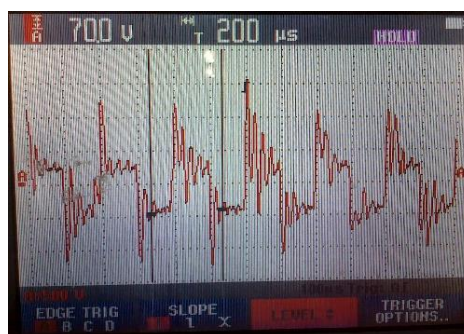

To limit such voltage transients, Phase can supply a tuned anti resonance filter (snubber) which must be assembled within 5 m of the motors, between the motor star terminal (white wire) and machine ground. Failure to connect the snubber may result in motor failure by insulator puncturing. Phase can supply different type of snubber depending on motor size.

NOTE: larger snubbers can dissipate a not negligible power (100-200W) and need to be mounted on a cooling surface. Check this requirement on the snubber drawing. On request Phase can supply special snubbers with a channel for liquid cooling.

Also, PMC suggest, in the first installation, to check the temperature of the snubber that do not exceed 90°C.



IMPORTANT NOTE: the values of snubber filter are calculated for a “typical” configuration. The actual configuration of the complete power supply chain (inverter PWM modulation method, type and length of the supply cables, type of series inductor and/or filter installed) can significantly modify the behaviour of the system. Consequently, it is strongly recommended that for each first installation of a new motor type or significant modification of the power supply components (such as different power amplifier type or brand) the star point voltage potential to ground with supplied snubber connected is acquired.

Test without snubber:

- Disconnect the snubber completely.
- Connect one terminal of the probe to the star-point and the other to GND.
- Before enabling the drive, make sure all cables are well connected and the active parts are well isolated.**
- Enable the drive with a 0 speed setpoint (locked rotor).
- Adjust the time and voltage scale on the oscilloscope to see the peaks of the common mode voltage created by the PWM of the drive. **Set the trigger high enough to obtain a stable signal** then stop the acquisition to see a still picture. **Disable the drive.** Then adjust the cursors to see the peak-to-peak voltage.
- Take note of the of the peak-to-peak voltage and save screenshot of the waveform with the cursors adjusted.
- Using vertical cursors, also the PWM frequency can be verified: if the period is 125 μ s, the PWM frequency is 8 kHz; if the period is 250 μ s, the PWM frequency is 4 kHz.

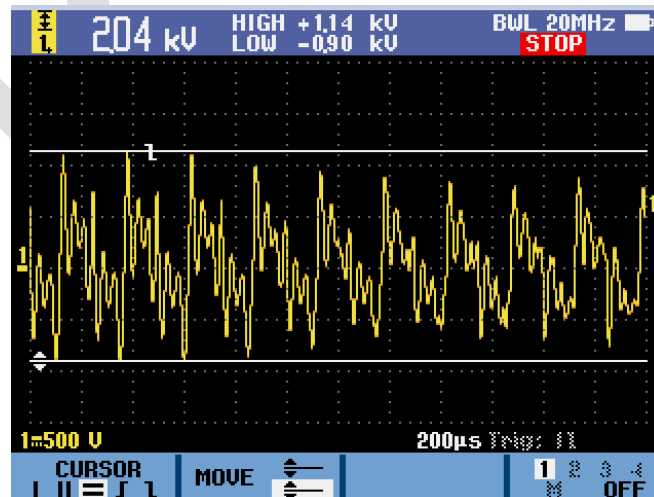

Example of a common mode voltage measurement.

Test with snubber:

-Connect the snubber between star-point and GND (White cable N°1 to star-point, White cable N°2 to GND, Yellow/Green cable to GND, Shield to GND).

-Connect one terminal of the probe to the star-point and the other to GND (since the snubber is connected there could be no space in the clamp to also connect the probe, in this case insert a small copper cable in the clamp with the snubber wires and connect the probe the other end of the cable).

-Before enabling the drive, make sure all cables are well connected and the active parts are well isolated.

-Enable the drive with a 0 speed setpoint (locked rotor).

-Adjust the time and voltage scale on the oscilloscope to see the peaks of the common mode voltage created by the PWM of the

drive. Set the trigger high enough to obtain a stable signal then stop the acquisition to see a still picture. **Disable the drive.** Then adjust the cursors to see the peak-to-peak voltage.

-Take note of the of the peak-to-peak voltage and save screenshot of the waveform with the cursors adjusted.

-Test results: The limit value of common mode voltage spikes is 2400 V peak-to-peak or 1200 V zero-to-peak (to obtain zero-to-peak value divide by 2 the peak-to-peak value). Values higher than 1100 V zero-to-peak start to be concerning and require the use of a snubber or other filters to reduce the spikes amplitude. If the snubber is in working order and it is well connected the common mode voltage will be reduced in the test with the snubber.

With actual motor insulation the limits are:

- Star point – GND 2400 Vpk-pk (1200 Vpk refer to zero)
- Phase – GND 2400 Vpk-pk (1200 Vpk refer to zero)
- Star point – Phase 2400 Vpk-pk (1200 Vpk refer to zero)
- Max dV/dT 6 kV/μsec in all the conditions

Motor integration

During mounting always refer to the assembly drawing in your hand.

Mounting and installation of TK motor are always operation strictly linked to the architecture of the machine where it must be installed, the following information are only general basic information for the correct handling of motor.

Stator

The stator installation does not have any critical item.

Checklist:

Wiring	Protect the wiring from being caught between metallic parts during assembly and bending in the conduits. Contact PHASE MOTION CONTROL if wiring appears damaged.
Winding heads	Generally, if not covered by protection flanges, the winding heads are vulnerable during the motor integration. avoid all accidental impact with metallic parts to protect the insulation. Contact PHASE MOTION CONTROL if damaged.
Liquid cooling	When the liquid cooling circuit is assembled and sealed, pay attention to avoid any loss of liquid from input/output nipples and prevent the cooling liquid from wetting with the windings. Contact PHASE MOTION CONTROL in case if loss of liquid on the winding.
Safety distance	If there are flanges or metallic parts in proximity of the winding heads, check that the minimum safety distance between the unprotected winding head and any grounded metallic part is kept, A value $>=6$ mm must be ensured to guarantee correct dielectric rigidity Should a shorter distance be unavoidable, supplementary insulation may be necessary. In this case contact PHASE MOTION CONTROL to obtain detailed instructions

Special warnings for liquid cooling systems:

- 1) With SQUID type frames, or anyway whenever the cooling cavity is made with adjacent rings and cuts according to Phase Motion technique, carefully check that the inlet and outlet bores are placed exactly opposite with respect to the nearest cooling ring cut and are centered on the first and last ring respectively. Frames with an even number of rings must have inlet and outlet on the same side; with an odd ring number, input and output are 180° opposite.
- 2) Make sure that under no circumstance the static pressure in the cooling chamber could exceed 500'000 Pa (5 Bar) to prevent motor deformation leading to O-Ring sealing failure (especially for motor diameter > 400 mm).
- 3) In motors supplied with Closed SQUID frame (with a carbon fiber sleeve closing the external cooling circuit) the static pressure in the cooling chamber can't exceed 300'000 Pa (3 Bar).
- 4) Should a mix of water and glycol be used in the cooling circuit, be advised that glycol tends to dissolve most seals with the except of VITON rubber. All O-rings supplied by Phase are made of VITON.
- 5) It is anyway better to mix the water with an appropriate ion neutralizer (such as ELF Chip Supra, Total 60L, Eurotherm Eurocold 131, Dowtherm SR-1) instead of Glycol with the additional benefit of limiting corrosion and clogging risk.
- 6) Do not cool the motor or parts thereof below room temperature to prevent condensation on the motor, which would quickly degenerate the winding.
- 7) As far as possible, water must be prevented from leaking on the winding even in case of O-Ring failure, by means of small drain holes and channels in the appropriate positions.

- 8) Always make sure that all air bubbles and pockets are removed from the circuit before performing a full power test and commissioning.

Rotor

The procedure for rotor assembly is determined by the type of coupling with the shaft

Checklist

Insertion of rotor to the shaft	All TK rotors have permanent magnets, so avoid mounting procedure using hot insertion, because there is a risk of rotor demagnetising if the temperature exceeds 80°C. Contact PHASE MOTION CONTROL in case of demagnetization
Shaft-Rotor coupling	Always respect interference value between shaft and rotor as indicated by PHASE MOTION CONTROL.
Carbon fiber sleeve	On this type of rotors check carefully the integrity of the sleeve. This preloaded unidirectional composite structure displays exceptional strength for high speed rotors but can be damaged by shocks. Contact PHASE MOTION CONTROL if rotor is damaged.

On request, rotors can be supplied with dual diameter and connection hole for hydraulic disassembly.

Mounting of the rotor inside the stator

Important warning: Avoid contact or close proximity of the bearings or parts thereof with the rotor magnets. Magnetized bearings, or magnetized cages, wear rapidly and catastrophically especially at high speed.

If special assembly tools or jigs have not been designed with the application, (i.e. special long shafts on which the rotor may slide, or positioning pins), then the rotor introduction is performed according to the following procedure:

- 1) Make ready a few (at least four) "shims", (flexible spacers made of non magnetic, not scratching, material, e.g. brass, copper, lexan or mylar) to interpose between rotor and stator. The shims should be at least 4 and are placed in the stator hole, equispaced on the internal circumference of the stator. The shims are best made with thickness approximately half of the theoretical mechanical air gap. This to guarantee a right centering and to achieve the extraction after rotor mounting. (Remark: on request Phase can supply mylar shims together with the motor).
- 2) Immediately prior to rotor insertion in the stator, peel the protective tape from the surface of the sleeve, check for cleanliness of the rotor surface; if any metallic part is attracted by the rotor, clean the surface peeling with an adhesive tape.
- 3) Position the rotor in front of the stator, well centered, making sure that the "shims" are in the correct positions, and that they can be removed after rotor insertion.
- 4) Insert the rotor; pay attention to the attraction force of the magnets that tend to "suck" the rotor inside the stator. This force is about 15 N/mm of rotor diameter and starts to be felt when the rotor is at some centimetres from the stator stack.
- 5) If a crane is used to move the rotor check for metallic parts in the rotor trajectory which could be attracted to the rotor causing damage
- 6) After rotor insertion the shaft/bearings can be locked, and the shims removed.

- 7) If the rotor interface is based on bearings on both sides of the rotor, the shims are extracted when only one bearing is in the correct position. Generally, assembly of the second bearing is possible, and the rotor will be re-centered if the last bearing seat is machined with a **proper conical chamfer**.

The photograph shows a mounting example.



Radial force vs. mounting eccentricity

The magnetic flux in the rotor generates radial attraction forces. These are perfectly balanced only if the rotor sits in the center of the stator and increase with eccentricity. In practice, this is equivalent to a “negative stiffness” which must be compensated by a much higher positive stiffness in the bearing system. The attraction data can be supplied on demand, the order of magnitude is shown in the graph in *Fig. 3*, for a 1000 Nm, 370 mm diameter, 105 mm long torque motor with a 1 mm radial airgap.

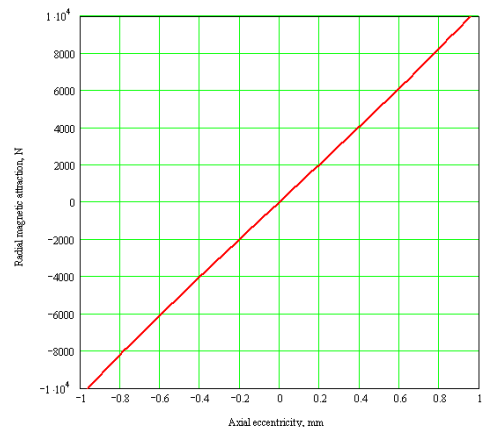

Fig.3 : Attraction force vs eccentricity

Check list after integration

- 1) After rotor installation, if possible, check that the rotation is free and there is no interference between rotor and stator.
- 2) Immediately perform a back-EMF testing and compare with the spec; if the back EMF is within +/- 8% of specified voltage and balance between the 3 phases is better than 5% the assembly is electrically and magnetically correct. Note the measured EMF value and the temperature of the measurement for possible, future diagnostics and rotor temperature measurement.
- 3) Repeat the motor insulation test (according to table in paragraph 6.1) to verify the proper connection and integrity of cables and to be sure that no damage occurred to the windings during installation. The "Spike Suppressor Unit" (if present) must be disconnected for this test. It is recommended to execute the test with a DC voltage (AC insulation test may be disruptive and test results can be affected by errors due to motor and cables capacitance to ground). Max. leakage current acceptable is 100 μ A stable or reducing in time.
- 4) Connect the "Spike Suppressor Unit" between the star point terminal of the motor and ground.
- 5) Check the proper sealing of the water cooling circuit (if present) by applying a pressure of 1.5 bar and verify that the same pressure is maintained.
- 6) Proceed with the electrical installation.
- 7) After machine completion proceed with insulation voltage testing according to the relevant local regulation (CE or UL-CSA).

IMPORTANT NOTE: in case of first installation of a new motor type execute the measure of winding voltage to ground as reported in previous chapter "Precautions".